

Middle Power LED Series  
3030

LM301H  
CRI 90

For Horticulture Lighting



#### Features & Benefits

- Middle power LED
- Mold resin for high reliability
- Standard form factor for design flexibility (3.0 × 3.0 mm)



## Table of Contents

1.	Characteristics	-----	3
2.	Product Code Information	-----	5
3.	Typical Characteristics Graphs	-----	10
4.	Outline Drawing & Dimension	-----	13
5.	Reliability Test Items & Conditions	-----	14
6.	Soldering Conditions	-----	15
7.	Tape & Reel	-----	16
8.	Label Structure	-----	18
9.	Packing Structure	-----	19
10.	Precautions in Handling & Use	-----	21

## 1. Characteristics

### a) Absolute Maximum Rating

Item	Symbol	Rating	Unit	Condition
Ambient / Operating Temperature	$T_a$	-40 ~ +85	°C	-
Storage Temperature	$T_{stg}$	-40 ~ +120	°C	-
LED Junction Temperature	$T_j$	110	°C	-
Forward Current	$I_F$	200	mA	-
Pulse Forward Current	$I_{FP}$	300	mA	Duty 1/10, pulse width 10ms
Assembly Process Temperature	-	260 <10	°C s	-
ESD (HBM)	-	5	kV	-

### b) Electro-optical Characteristics ( $I_F = 65 \text{ mA}$ , $T_s = 25 \text{ °C}$ )

Item	Unit	Rank	Bin	Min.	Typ.	Max.
Forward Voltage ( $V_F$ )	V	XA	AY	2.6	-	2.7
			AZ	2.7	-	2.8
			A1	2.8	-	2.9
Reverse Voltage (@ 5 mA)	V			0.7	-	1.2
Color Rendering Index ( $R_a$ )	-			90	-	-
Thermal Resistance (junction to solder point)	°C/W			-	7.5	-
Beam Angle	°			-	120	-

#### Note:

Samsung maintains measurement tolerance of: forward voltage =  $\pm 0.1 \text{ V}$ , luminous flux =  $\pm 5 \%$ , CRI =  $\pm 3$

c) Electro-optical Characteristics ( $T_s = 25\text{ }^\circ\text{C}$ )

Item	CRI	Nominal CCT (K)	SF		SG		SH		SJ		Current
			Min.	Max.	Min.	Max.	Min.	Max.	Min.	Max.	
			28	30	30	32	32	34	34	36	65mA
Luminous Flux ( $\Phi_v$ )	90	2700									
		3000									
		3500									
		4000									
		5000									
		5700									
		6500									

**Note:**

Samsung maintains measurement tolerance of: forward voltage =  $\pm 0.1\text{V}$ , luminous flux =  $\pm 5\%$ , CRI =  $\pm 3$

## 2. Product Code Information

1	2	3	4	5	6	7	8	9	10	11	12	13	14	15	16	17	18
S	P	M	W	H	D	3	2	A	M	H	7	X	A	R	0	S	0

Digit	PKG Information	Code	Specification
1 2 3	Samsung Package Middle Power	<b>SPM</b>	
4 5	Color	<b>WH</b>	White
6	Product Version	<b>D</b>	Dispensing
7 8 9	Form Factor	<b>32A</b>	3.0 x 3.0 x 0.7 mm; 2 pads;
10	Sorting Current (mA)	<b>M</b>	65 mA
11	Chromaticity Coordinates	<b>H</b>	Horticulture
12	CRI	<b>7</b>	Min. 90
13 14	Forward Voltage (V)	<b>XA</b>	2.6~2.9      Bin Code: AY 2.6~2.7 AZ 2.7~2.8 4,000 pcs/Reel      A1 2.8~2.9
15 16	CCT (K)	<b>W•</b>	2700      WE, WF, WG, WH, WJ, WK, WL, WM
		<b>V•</b>	3000      VE, VF, VG, VH, VJ, VK, VL, VM, Bin Code:
		<b>U•</b>	3500      UE, UF, UG, UH, UJ, UK, UL, UM
		<b>T•</b>	4000      TE, TF, TG, TH, TJ, TK, TL, TM
		<b>R•</b>	5000      RE, RF, RG, RH, RJ, RK, RL, RM
		<b>Q•</b>	5700      Bin Code: QE, QF, QG, QH, QJ, QK, QL, QM
		<b>P•</b>	6500      PE, PF, PG, PH, PJ, PK, PL, PM
			• : "0" (Whole bin) , "5" (MacAdam 5-step ellipse bin)
17 18	Luminous Flux	<b>S0</b>	SF, SG, SH, SJ
		<b>SF</b>	SF 28.0 ~ 30.0
		<b>SG</b>	Bin Code: SG 30.0 ~ 32.0
		<b>SH</b>	SH 32.0 ~ 34.0
		<b>SJ</b>	SJ 34.0 ~ 36.0

a) Luminous Flux Bins( $I_f = 65 \text{ mA}$ ,  $T_s = 25^\circ\text{C}$ )

CRI ( $R_a$ ) Min.	Nominal CCT (K)	Product Code	Flux Bin	Flux Range ( $\Phi_v$ , lm)
90	2700	SPMWHD32AMH7XAW●S0	SF	28.0 ~ 30.0
			SG	30.0 ~ 32.0
	3000	SPMWHD32AMH7XAV●S0	SF	28.0 ~ 30.0
			SG	30.0 ~ 32.0
	3500	SPMWHD32AMH7XAU●S0	SG	30.0 ~ 32.0
			SH	32.0 ~ 34.0
	4000	SPMWHD32AMH7XAT●S0	SG	30.0 ~ 32.0
			SH	32.0 ~ 34.0
	5000	SPMWHD32AMH7XAR●S0	SG	30.0 ~ 32.0
			SH	32.0 ~ 34.0
			SJ	34.0 ~ 36.0
	5700	SPMWHD32AMH7XAQ●S0	SG	30.0 ~ 32.0
			SH	32.0 ~ 34.0
			SJ	34.0 ~ 36.0
	6500	SPMWHD32AMH7XAP●S0	SG	30.0 ~ 32.0
			SH	32.0 ~ 34.0
SJ			34.0 ~ 36.0	

**Note:**

"●" can be "0" (Whole bin) and "5"(MacAdam 5-step ellipse)

**b) Color Bins ( $I_F = 65 \text{ mA}$ ,  $T_s = 25 \text{ }^\circ\text{C}$ )**

CRI (Ra) Min.	Nominal CCT (K)	Product Code	Color Rank	Chromaticity Bins
90	2700	SPMWHD32AMH7XAW0S0	W0 (Whole bin)	WE, WF, WG, WH, WJ, WK, WL, WM
		SPMWHD32AMH7XAW5S0	W5 (MacAdam 5-step)	WE, WF, WG, WH
	3000	SPMWHD32AMH7XAV0S0	V0 (Whole bin)	VE, VF, VG, VH, VJ, VK, VL, VM
		SPMWHD32AMH7XAV5S0	V5 (MacAdam 5-step)	VE, VF, VG, VH
	3500	SPMWHD32AMH7XAU0S0	U0 (Whole bin)	UE, UF, UG, UH, UJ, UK, UL, UM
		SPMWHD32AMH7XAU5S0	U5 (MacAdam 5-step)	UE, UF, UG, UH
	4000	SPMWHD32AMH7XAT0S0	T0 (Whole bin)	TE, TF, TG, TH, TJ, TK, TL, TM
		SPMWHD32AMH7XAT5S0	T5 (MacAdam 5-step)	TE, TF, TG, TH
	5000	SPMWHD32AMH7XAR0S0	R0 (Whole bin)	RE, RF, RG, RH, RJ,RK,RL,RM
		SPMWHD32AMH7XAR5S0	R5 (MacAdam 5-step)	RE, RF, RG, RH
	5700	SPMWHD32AMH7XAQ0S0	Q0 (Whole bin)	QE, QF, QG, QH, QJ,QK,QL,QM
		SPMWHD32AMH7XAQ5S0	Q5 (MacAdam 5-step)	QE, QF, QG, QH
	6500	SPMWHD32AMH7XAP0S0	P0 (Whole bin)	PE, PF, PG, PH, PJ,PK,PL,PM,
		SPMWHD32AMH7XAP5S0	P5 (MacAdam 5-step)	PE, PF, PG, PH

**c) Voltage Bins ( $I_F = 65 \text{ mA}$ ,  $T_s = 25 \text{ }^\circ\text{C}$ )**

CRI (Ra) Min.	Nominal CCT (K)	Product Code	Voltage Rank	Voltage Bin	Voltage Range (V)
90	-	-	XA	AY	2.6 ~ 2.7
				AZ	2.7 ~ 2.8
				A1	2.8 ~ 2.9

d) Chromaticity Region & Coordinates ( $I_F = 65 \text{ mA}$ ,  $T_s = 25 \text{ }^\circ\text{C}$ )

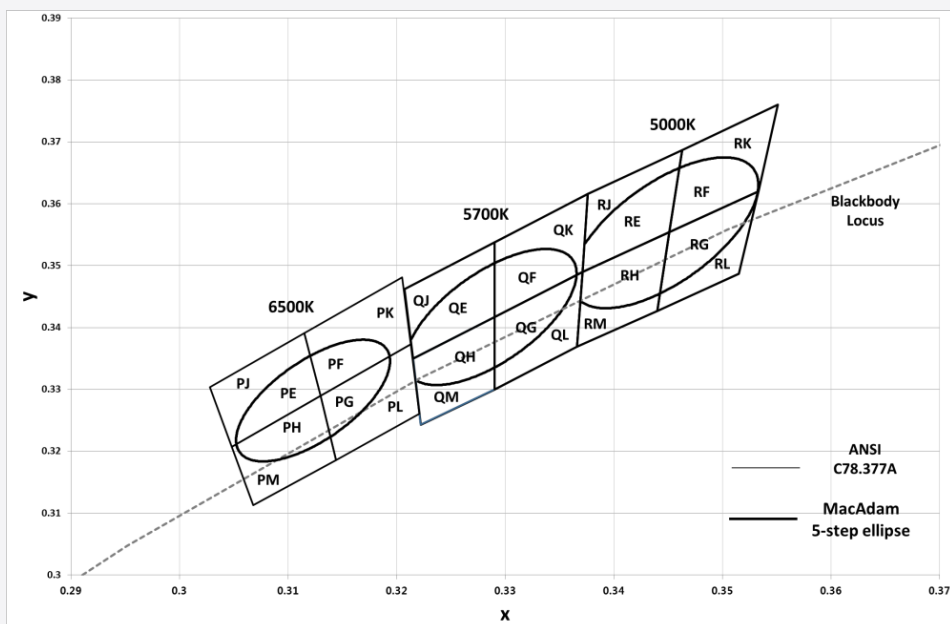
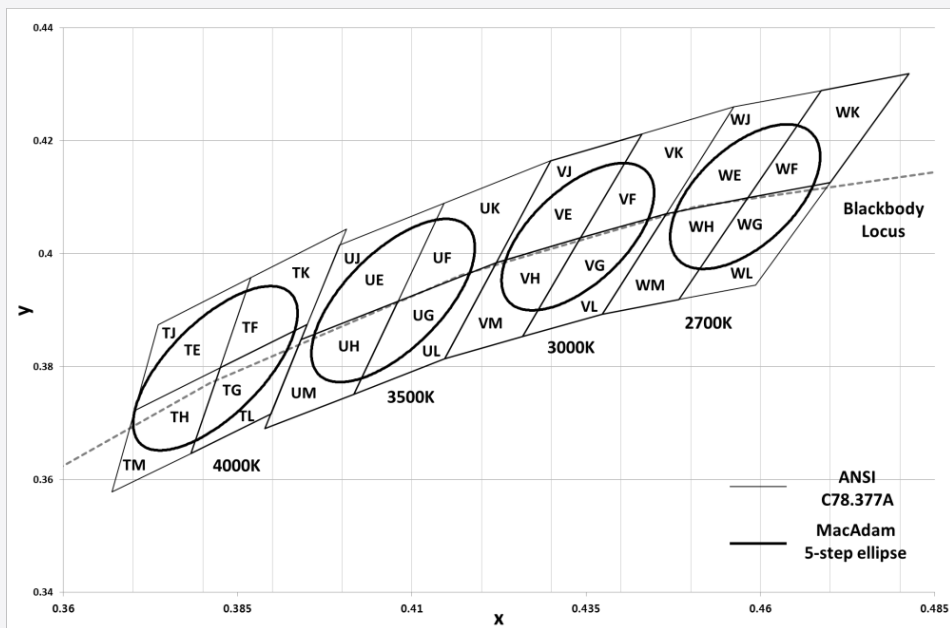



e) Chromaticity Region & Coordinates ( $I_F = 65 \text{ mA}$ ,  $T_s = 25 \text{ }^\circ\text{C}$ )

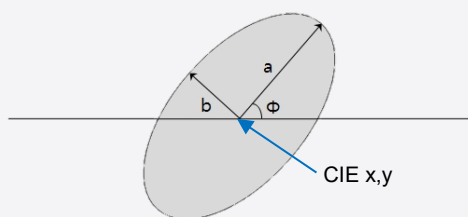

MacAdam Ellipse (W5)					
Step	CIE x	CIE y	$\theta$	a	b
5-step	0.4578	0.4101	53.70	0.01350	0.00700

MacAdam Ellipse (V5)					
Step	CIE x	CIE y	$\theta$	a	b
5-step	0.4338	0.4030	53.22	0.01390	0.00680

MacAdam Ellipse (U5)					
Step	CIE x	CIE y	$\theta$	a	b
5-step	0.4073	0.3917	54.00	0.01545	0.00690

MacAdam Ellipse (T5)					
Step	CIE x	CIE y	$\theta$	a	b
5-step	0.3818	0.3797	53.72	0.01565	0.00670

MacAdam Ellipse (R5)					
Step	CIE x	CIE y	$\theta$	a	b
5-step	0.3447	0.3553	59.62	0.01370	0.00590

MacAdam Ellipse (Q5)					
Step	CIE x	CIE y	$\theta$	a	b
5-step	0.3287	0.3417	59.09	0.01243	0.00533

MacAdam Ellipse (P5)					
Step	CIE x	CIE y	$\theta$	a	b
5-step	0.3123	0.3282	58.57	0.01115	0.00475

**Note:**

Samsung maintains measurement tolerance of:  $C_x, C_y = \pm 0.005$

### 3. Typical Characteristics Graphs

#### a) Spectrum Distribution ( $I_f = 65 \text{ mA}$ , $T_s = 25 \text{ }^\circ\text{C}$ )

CCT : 2700K (90 CRI)

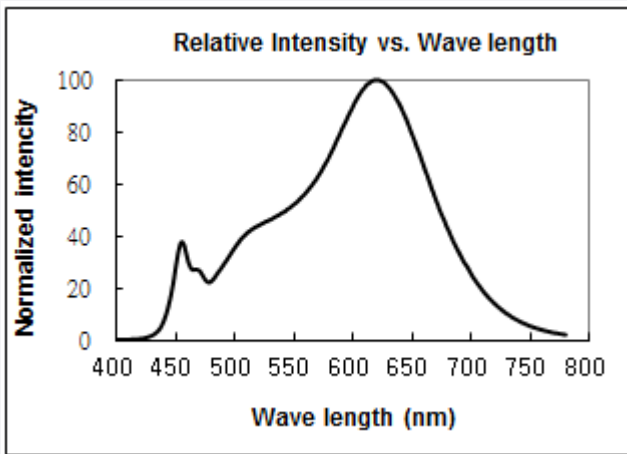

CCT : 3000K (90 CRI)

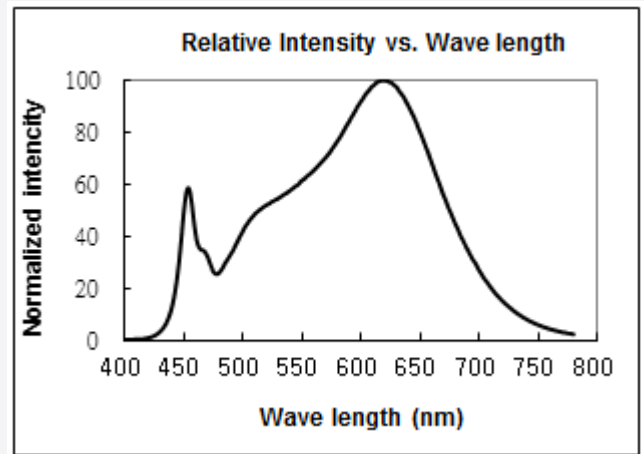

CCT : 3500K (90 CRI)

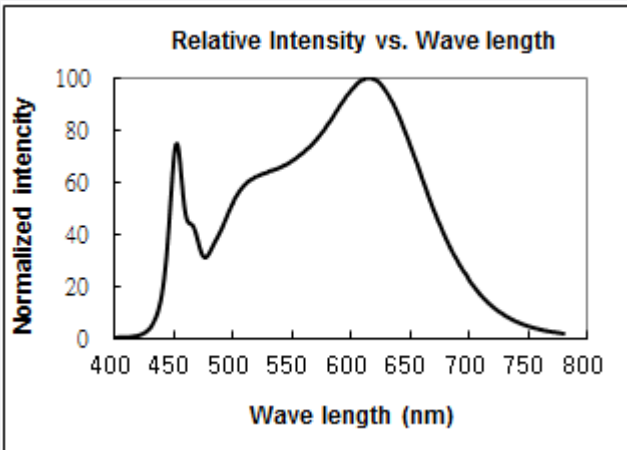

CCT : 4000K (90 CRI)

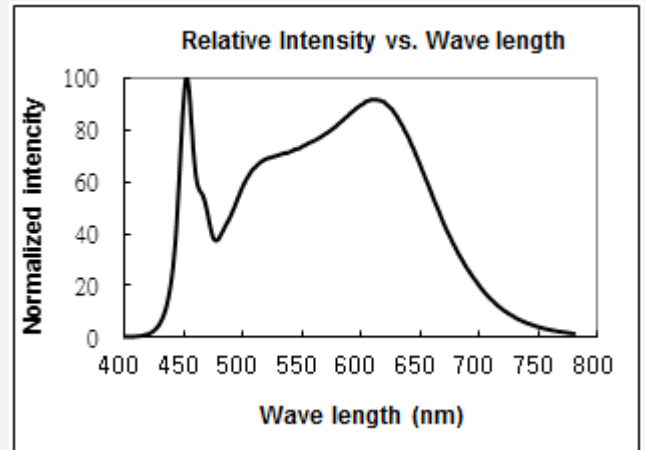

CCT : 5000K (90 CRI)

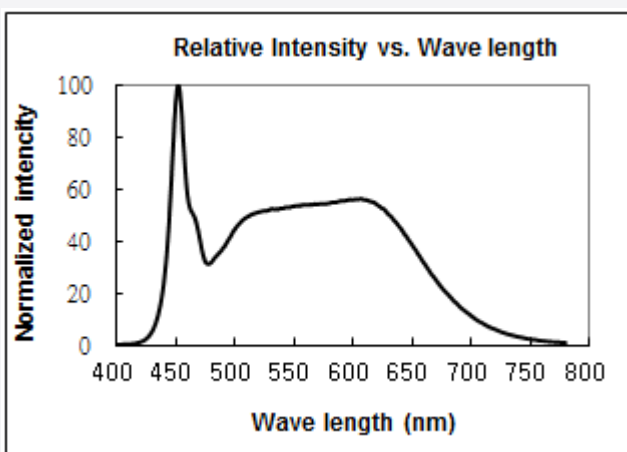

CCT : 5700K (90 CRI)

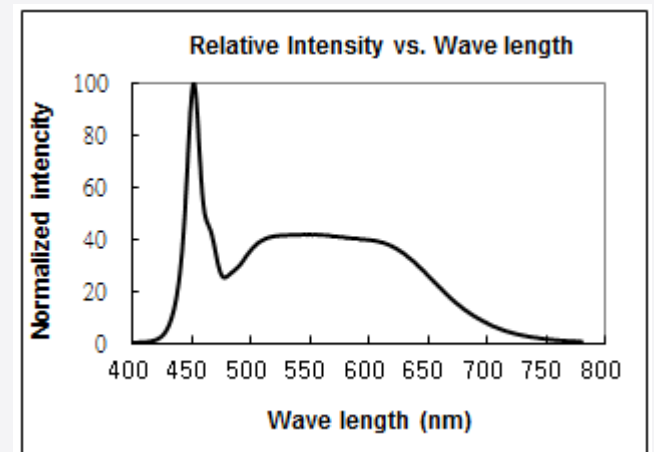

CCT : 6500K (90 CRI)

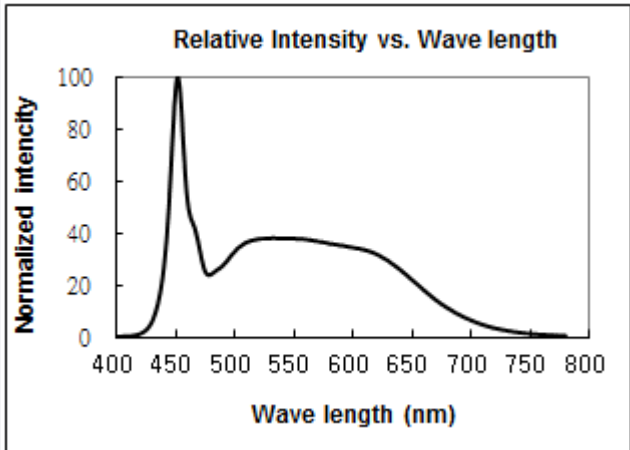

**b) Forward Current Characteristics ( $T_s = 25\text{ }^\circ\text{C}$ )**

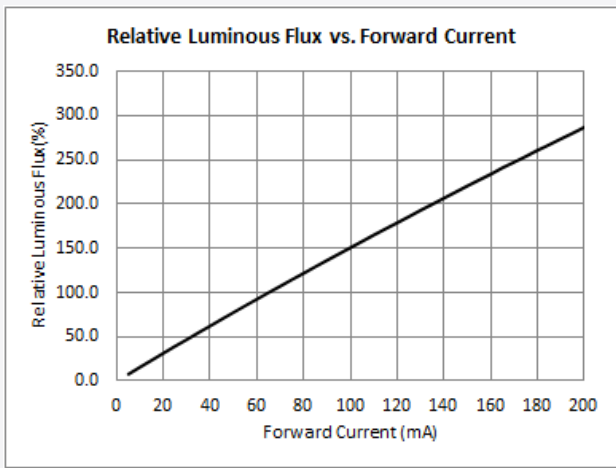
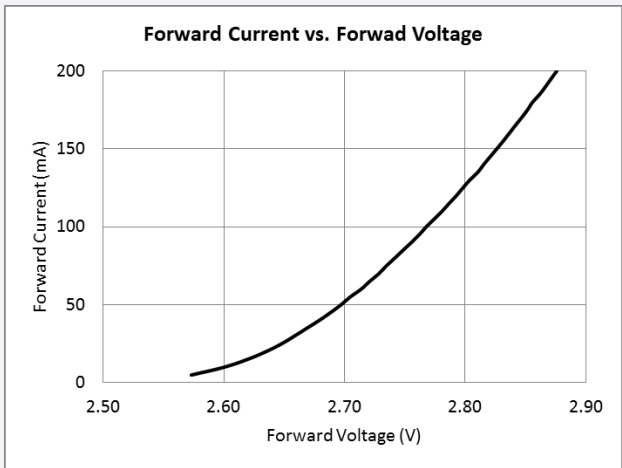

**c) Temperature Characteristics ( $I_F = 65\text{ mA}$ )**

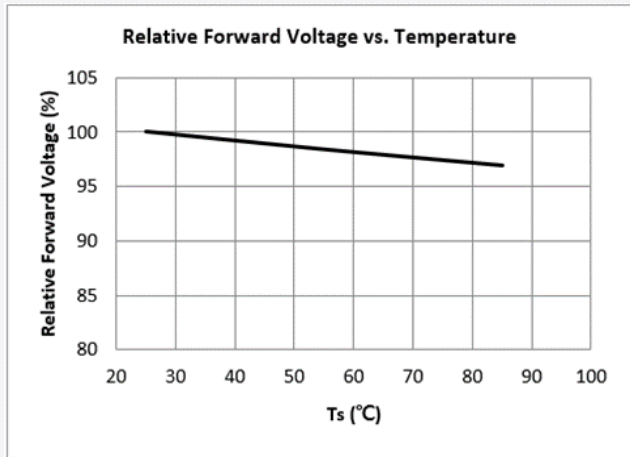
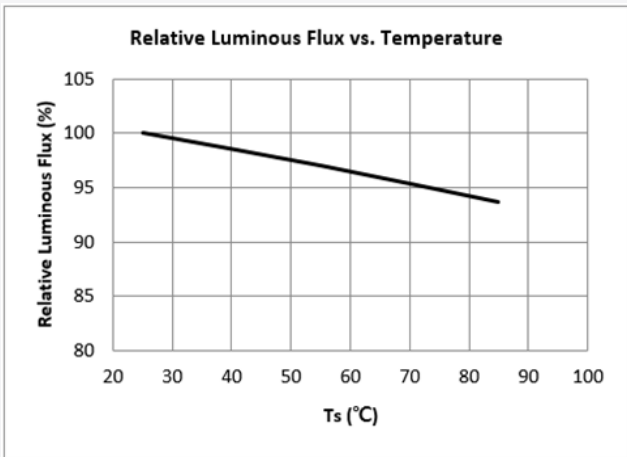

d) Color Shift Characteristics,  $T_s = 25\text{ }^\circ\text{C}$ ,  $I_F = 65\text{ mA}$

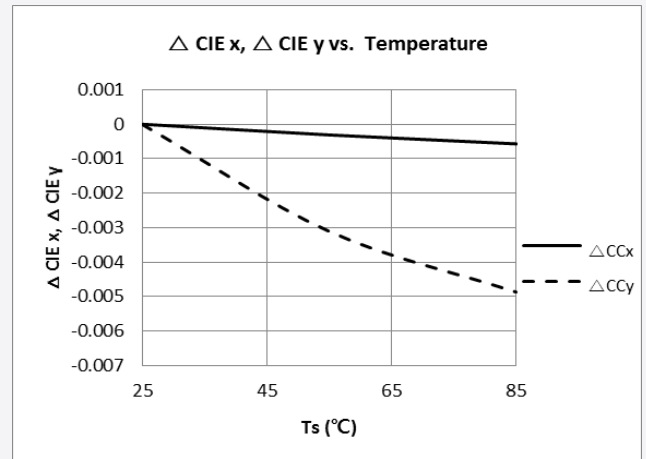
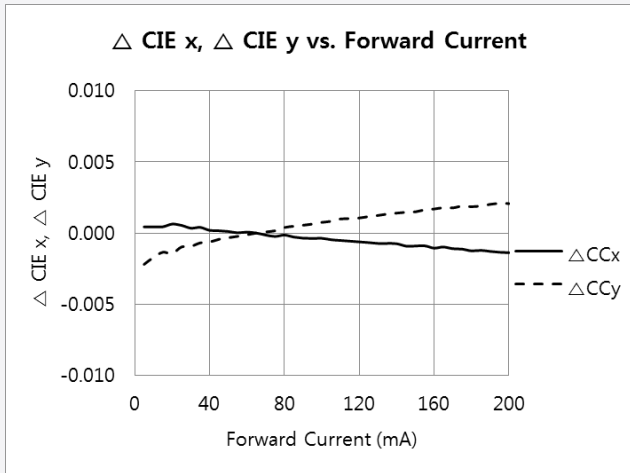

e) Derating Curve

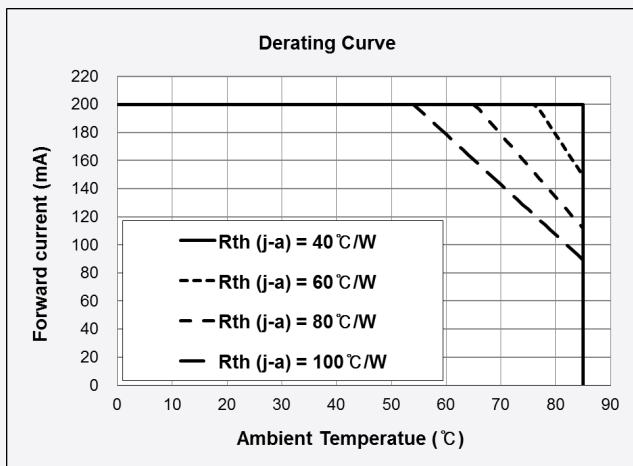

f) Beam Angle Characteristics ( $T_s = 25\text{ }^\circ\text{C}$ ,  $I_F = 65\text{ mA}$ )

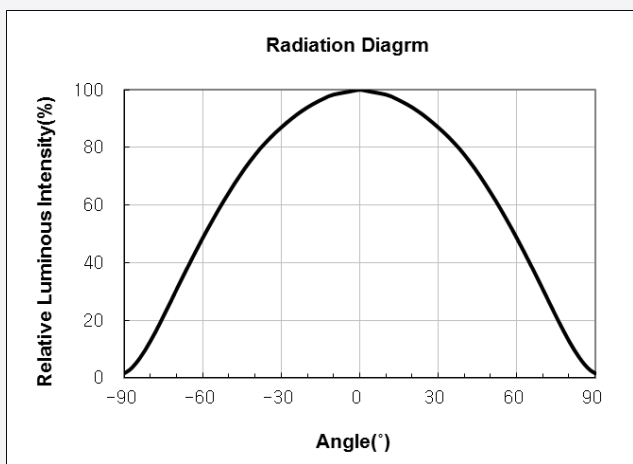

#### 4. Outline Drawing & Dimension

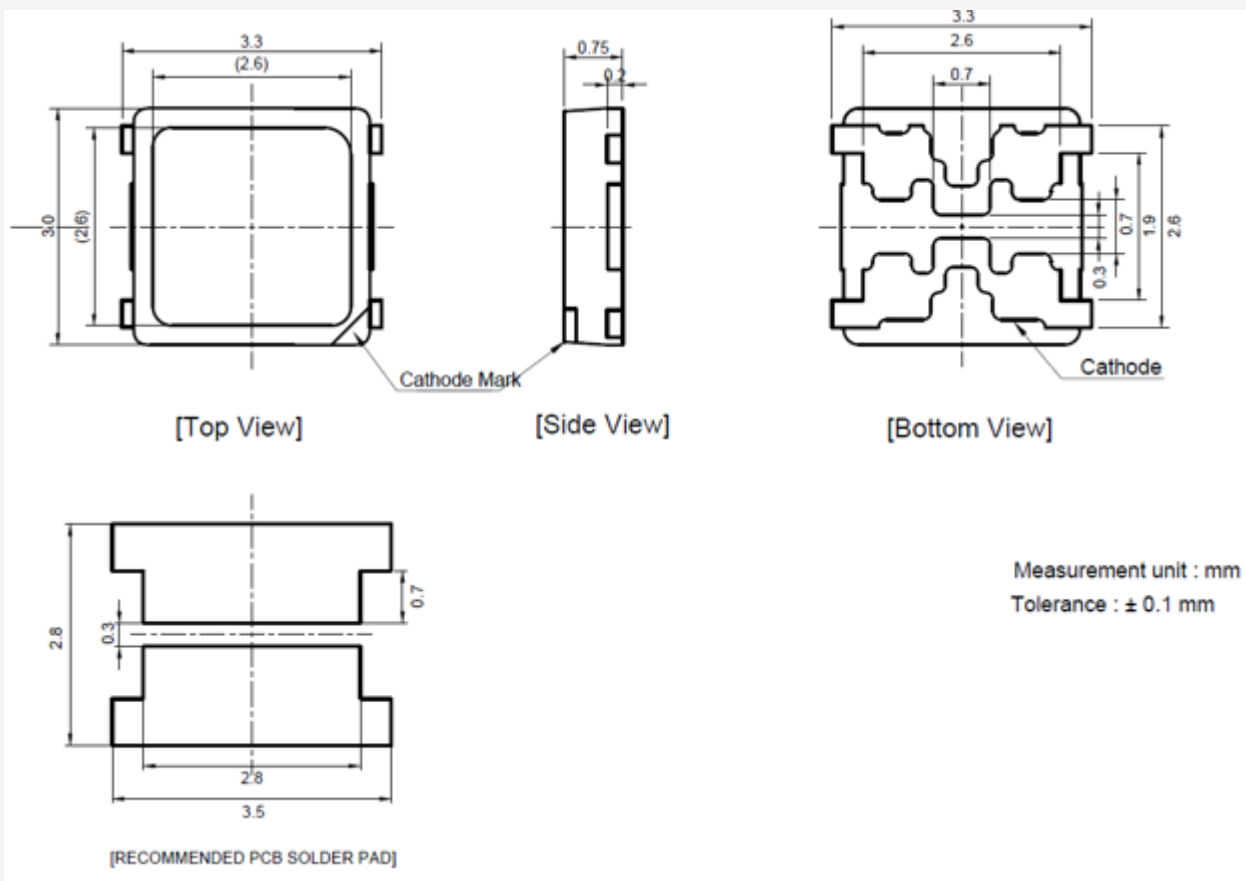

#### Notes:

- 1) This LED has built-in ESD protection device(s) connected in parallel to LED chip(s).
- 2)  $T_s$  point and measurement method:
  - ① Measure one point at the cathode pad, if necessary remove PSR of PCB to reach  $T_s$  point.
  - ② All pads must be soldered to the PCB to dissipate heat properly, otherwise the LED can be damaged.

#### Precautions:

- 1) Pressure on the LEDs will influence to the reliability of the LEDs. Precautions should be taken to avoid strong pressure on the LEDs. Do not put stress on the LEDs during heating.
- 2) Re-soldering should not be done after the LEDs have been soldered. If re-soldering is unavoidable, LED's characteristics should be carefully checked before and after such repair.
- 3) Do not stack assembled PCBs together. Since materials of LEDs is soft, abrasion between two PCB assembled with LED might cause catastrophic failure of the LEDs.

## 5. Reliability Test Items & Conditions

### a) Test Items

Test Item	Test Condition	Test Hour / Cycle	Sample No.
Room Temperature Life Test	25 °C, DC 200 mA	1000 h	22
High Temperature Life Test	85 °C, DC 200 mA	1000 h	22
High Temperature Humidity Life Test	60°C, 90% RH, DC 200 mA	1000 h	22
Low Temperature Life Test	-40 °C, DC 200 mA	1000 h	22
Powered Temperature Cycle Test	-40 °C ~ 85 °C, each 10 min, On/Off 5min , Temp. Change Time 20min, DC 200 mA	100 cycles	22
Thermal Cycle	-45 °C / 15 min ↔ 125 °C / 15 min → Hot plate 180 °C	500 cycles	100
High Temperature Storage	120 °C	1000 h	11
Low Temperature Storage	-40 °C	1000 h	11
ESD (HBM)		R <sub>1</sub> : 10 MΩ R <sub>2</sub> : 1.5 kΩ C: 100 pF V: ±5 kV	5 times 30
ESD (MM)		R <sub>1</sub> : 10 MΩ R <sub>2</sub> : 0 C: 200 pF V: ±0.5 kV	5 times 30
Vibration Test	20~2000~20 Hz, 200 m/s <sup>2</sup> , sweep 4 min X, Y, Z 3 direction, each 1 cycle	4 cycles	11
Mechanical Shock Test	1500 g, 0.5 ms 3 shocks each X-Y-Z axis	5 cycles	11

### b) Criteria for Judging the Damage

Item	Symbol	Test Condition (T <sub>s</sub> = 25 °C)	Limit	
			Min	Max
Forward Voltage	V <sub>F</sub>	I <sub>F</sub> = 65 mA	Init. Value * 0.9	Init. Value * 1.1
Luminous Flux	Φ <sub>v</sub>	I <sub>F</sub> = 65 mA	Init. Value * 0.7	Init. Value * 1.1

## 6. Soldering Conditions

### a) Reflow Conditions (Pb free)

Reflow frequency: 2 times max.

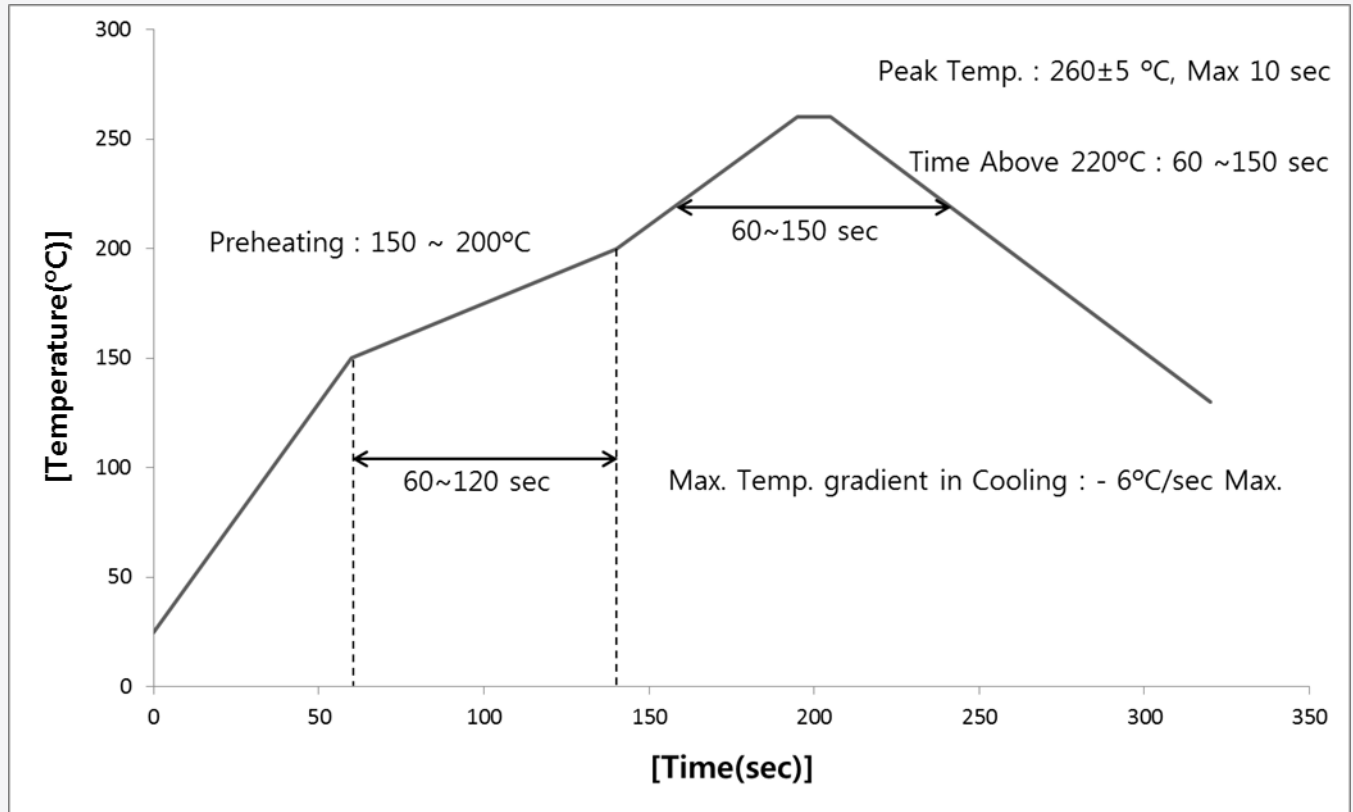

### b) Manual Soldering Conditions

Not more than 5 seconds @ max. 300 °C, under soldering iron.

## 7. Tape & Reel

### a) Taping Dimension

(unit: mm)

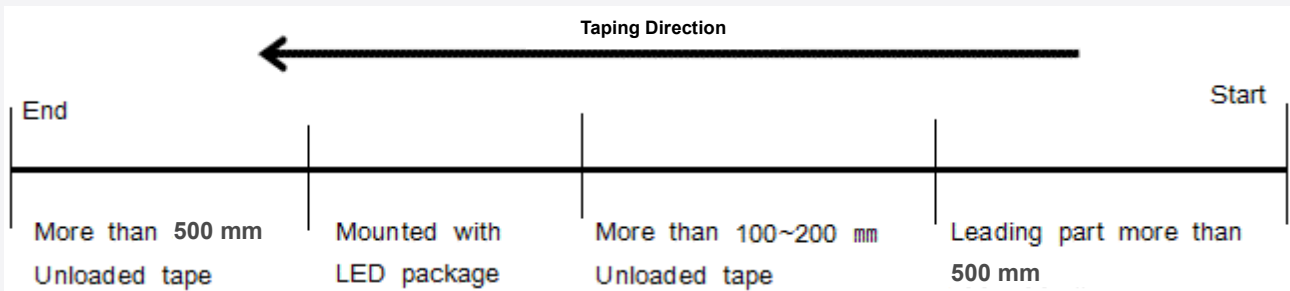
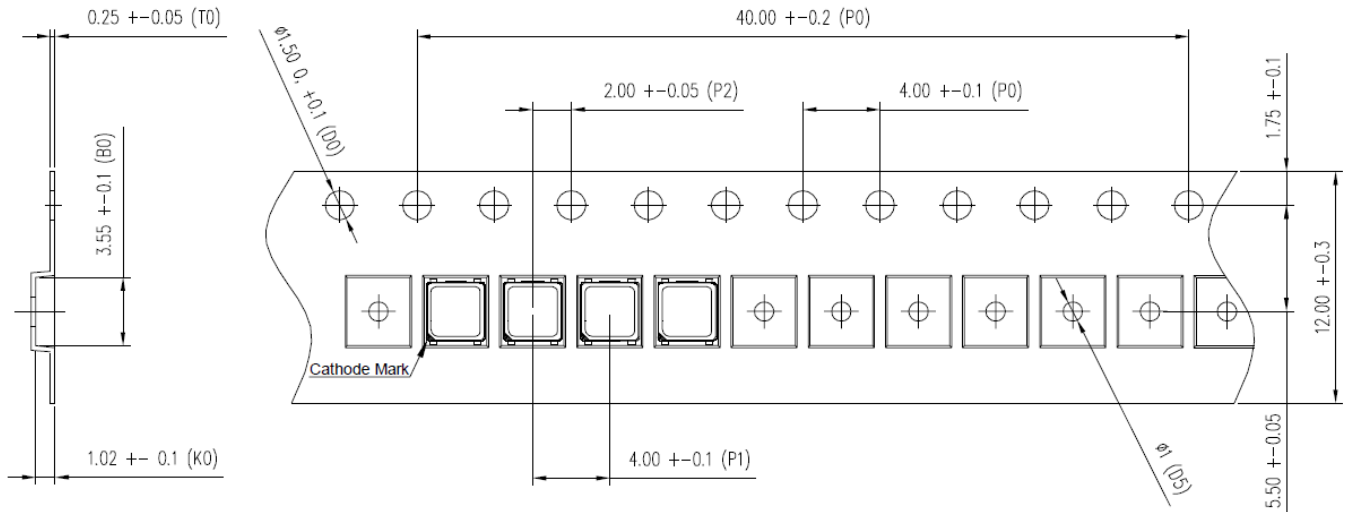



## b) Reel Dimension

(unit: mm)

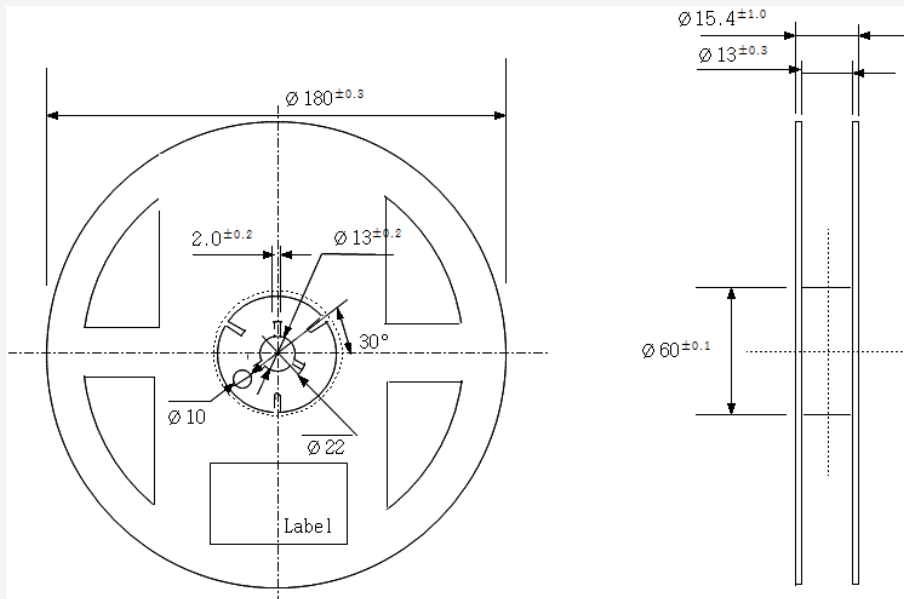
**Notes:**

- 1) Quantity: The quantity/reel is 4,000 pcs
- 2) Cumulative Tolerance: Cumulative tolerance / 10 pitches is  $\pm 0.2$  mm
- 3) Adhesion Strength of Cover Tape: Adhesion strength is 0.1-0.7 N when the cover tape is turned off from the carrier tape at  $10^\circ$  angle to the carrier tape
- 4) Packaging: P/N, Manufacturing data code no. and quantity are indicated on the aluminum packing bag

## 8. Label Structure

### a) Label Structure

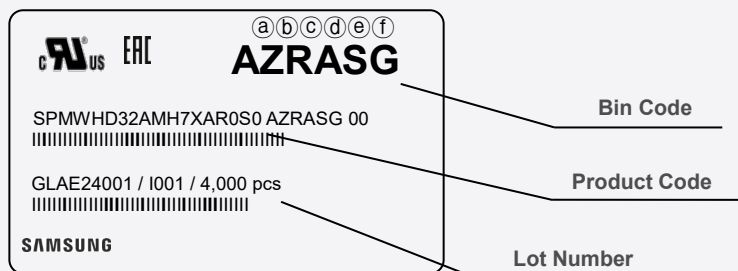

Note: Denoted bin code and product code above is only an example (see description on page 5)

Bin Code:

ⒶⒷ: Forward Voltage bin (refer to page 8)

ⒸⒹ: Chromaticity bin (refer to page 10-13)

ⒺⒻ: Luminous Flux bin (refer to page 8)

### b) Lot Number

The lot number is composed of the following characters:



①②③④⑤⑥⑦⑧⑨ / IⒶⒷⒸ / 4,000 pcs

①② : Production site (GL: Tianjin, China, G4: Guangzhou, China, EH : Hanoi, Vietnam )  
 ※ Sample product (SL: Kiheung, Korea)

③ : Product state (A: Normal, B: Bulk, C: First Production, R: Reproduction, S: Sample)

④ : Year (C : 2018, D : 2019, E : 2020 ...)

⑤ : Month (1~9, A, B, C)

⑥ : Day (1~9, A, B~V)

⑦⑧⑨ : Serial number (001 ~ 999)

ⒶⒷⒸ : Reel number (001 ~ 999)

## 9. Packing Structure

### a) Packing Process (The quantity of PKG on the Reel to be Max 4,000pcs)

#### Reel

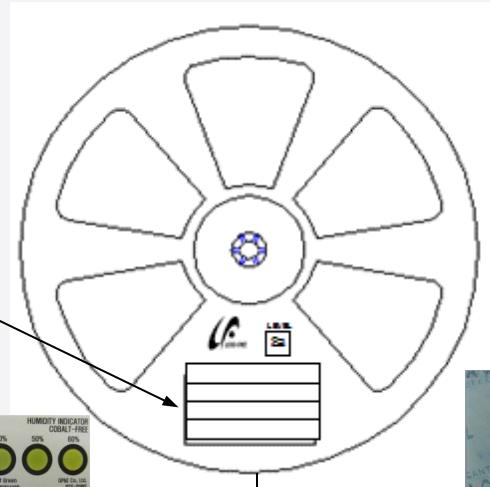
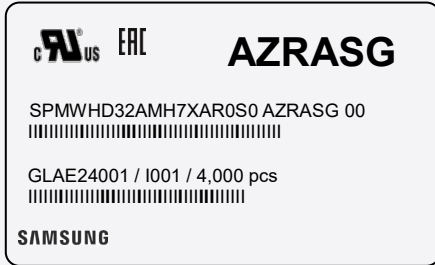

#### Aluminum Vinyl Packing Bag

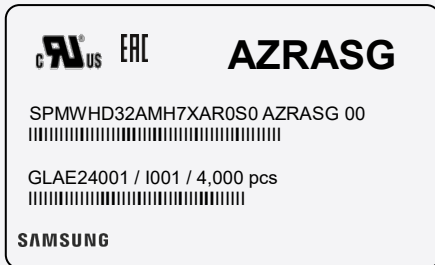

#### Outer Box

Material: Paper (SW3B(B))

Type	Size (mm)			Note
	L	W	H	
7 inch L	245 ± 5	220 ± 5	182 ± 5	Up to 10 reels
7 inch S	245 ± 5	220 ± 5	86 ± 5	Up to 5 reels

#### ① Side Label

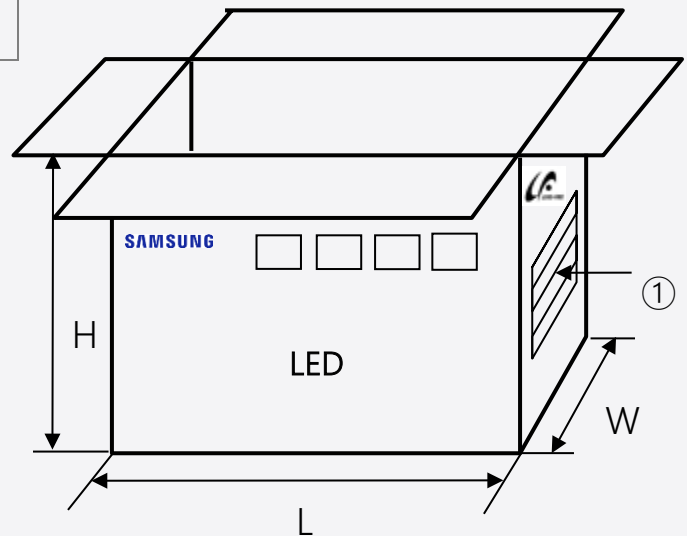
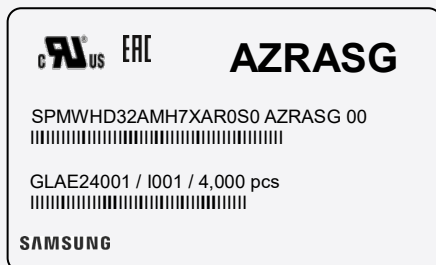



## 10. Precautions in Handling & Use

- 1) For over-current protection, users are recommended to apply resistors connected in series with the LEDs to mitigate sudden change of the forward current caused by shift of forward voltage.
- 2) This device should not be used in any type of fluid such as water, oil, organic solvent, etc. When cleaning is required, IPA is recommended as the cleaning agent. Some solvent-based cleaning agent may damage the silicone resins used in the device.
- 3) When the device is in operation, the forward current should be carefully determined considering the maximum ambient temperature and corresponding junction temperature.
- 4) LEDs must be stored in a clean environment. Shelf life of sealed bags is 12 months at temperature 0~40 °C, 0~90 % RH.
- 5) After storage bag is opened, device subjected to soldering, solder reflow, or other high temperature processes must be:
  - a. Mounted within 672 hours (28 days) at an assembly line with a condition of no more than 30 °C / 60 % RH\*<sup>Note 1</sup>, or
  - b. Mounted within 24 hours (1 day) at an assembly line with a condition of more than 30 °C / 70 % RH\*<sup>Note 2</sup>, or
  - c. Stored at <10 % RH.

\*Note 1, 2: IPC/JEDEC J-STD-033A, Recommended Equivalent Total Floor Life Table

Package Type and Body Thickness	Moisture Sensitivity Level	Maximum Percent Relative Humidity						Temperature
		40%	50%	60%	70%	80%	90%	
Body Thickness <2.1mm	Level 2a	∞	∞	28	1	1	1	30°C
		∞	∞	∞	2	1	1	25°C
		∞	∞	∞	2	2	1	20°C

- 6) Repack unused devices with anti-moisture packing, fold to close any opening and then store in a dry place.
- 7) Devices require baking before mounting, if humidity card reading is >60 % at 23 ± 5 °C.
- 8) Devices must be baked for 10~24 hours at 60 ± 5 °C, if baking is required.
- 9) The LEDs are sensitive to the static electricity and surge current. It is recommended to use a wrist band or anti-electrostatic glove when handling the LEDs. If voltage exceeding the absolute maximum rating is applied to LEDs, it may cause damage or even destruction to LED devices. Damaged LEDs may show some unusual characteristics such as increase in leakage current, lowered turn-on voltage, or abnormal lighting of LEDs at low current.
- 10) VOCs (Volatile Organic Compounds) can be generated from adhesives, flux, hardener or organic additives used in luminaires (fixtures). Transparent LED silicone encapsulant is permeable to those chemicals and they may lead to a discoloration of encapsulant when they exposed to heat or light. This phenomenon can cause a significant loss of light emitted (output) from the luminaires. In order to prevent these problems, we recommend users to know the physical properties of materials used in luminaires and they must be carefully selected.
- 11) Risk of sulfurization (or tarnishing)  
 The LED from Samsung uses a silver-plated lead frame and its surface color may change to black (or dark colored) when it is exposed to sulfur (S), chlorine (Cl) or other halogen compound. Sulfurization of lead frame may cause intensity degradation, change of chromaticity coordinates and, in extreme cases, open circuit. It requires caution. Due to possible sulfurization of lead frame, LED should not be used and stored together with oxidizing substances made of materials such as rubber, plain paper, lead solder cream, etc.

# Legal and additional information.

## [About Samsung Electronics Co., Ltd.](#)

Samsung inspires the world and shapes the future with transformative ideas and technologies.

The company is redefining the worlds of TVs, smartphones, wearable devices, tablets, digital appliances, network systems, and memory, system LSI, foundry and LED solutions. For the latest news, please visit the Samsung Newsroom at [news.samsung.com](http://news.samsung.com).

"Samsung provides limited warranty for its LED products, the full text of which is available at <https://www.samsung.com/led/support/warranties>"

Copyright © 2020 Samsung Electronics Co., Ltd. All rights reserved.

Samsung is a registered trademark of Samsung Electronics Co., Ltd.

Specifications and designs are subject to change without notice. Non-metric weights and measurements are approximate. All data were deemed correct at time of creation. Samsung is not liable for errors or omissions. All brand, product, service names and logos are trademarks and/or registered trademarks of their respective owners and are hereby recognized and acknowledged.

Samsung Electronics Co., Ltd.

95, Samsung 2-ro

Giheung-gu

Yongin-si, Gyeonggi-do, 446-711

KOREA

[www.samsungled.com](http://www.samsungled.com)

**SAMSUNG**