

Middle Power LED Series
3030

LM302Z+ ECO
CRI 80



Features & Benefits

- 0.9 W class middle power LED
- Mold resin for high reliability
- Standard form factor for design flexibility (3.0 × 3.0 mm)

Table of Contents

| | | | |
|-----|-------------------------------------|-------|----|
| 1. | Characteristics | ----- | 3 |
| 2. | Product Code Information | ----- | 4 |
| 3. | Typical Characteristics Graphs | ----- | 11 |
| 4. | Outline Drawing & Dimension | ----- | 14 |
| 5. | Reliability Test Items & Conditions | ----- | 15 |
| 6. | Soldering Conditions | ----- | 16 |
| 7. | Tape & Reel | ----- | 17 |
| 8. | Label Structure | ----- | 19 |
| 9. | Packing Structure | ----- | 20 |
| 10. | Precautions in Handling & Use | ----- | 23 |

1. Characteristics

a) Absolute Maximum Rating

| Item | Symbol | Rating | Unit | Condition |
|---------------------------------|-----------|------------|---------|-----------------------------|
| Ambient / Operating Temperature | T_a | -40 ~ +85 | °C | - |
| Storage Temperature | T_{stg} | -40 ~ +100 | °C | - |
| LED Junction Temperature | T_j | 125 | °C | - |
| Forward Current | I_F | 200 | mA | - |
| Pulse Forward Current | I_{FP} | 300 | mA | Duty 1/10, pulse width 10ms |
| Assembly Process Temperature | - | 260 <10 | °C s | - |
| ESD (HBM) | - | 2 | kV | - |

Note:

Proper current derating must be observed to maintain junction temperature below the maximum at all time.

ESD (HBM) rating means PASS with 80% probability.

b) Electro-optical Characteristics ($I_F = 150 \text{ mA}$, $T_s = 25^\circ\text{C}$)

| Item | Unit | Rank | Bin | Min. | Typ. | Max. |
|--|------|------|-----|------|------|------|
| Forward Voltage (VF) | V | GN | AZ | 6.0 | - | 6.1 |
| | | | A1 | 6.1 | - | 6.2 |
| Color Rendering Index (R_a) | - | 5 | | 80 | - | - |
| Thermal Resistance (junction to solder point) | °C/W | | | - | 12 | - |
| Beam Angle | ° | | | - | 120 | - |

Note:

Samsung maintains measurement tolerance of: forward voltage = $\pm 0.1 \text{ V}$, luminous flux = $\pm 5 \%$, CRI = ± 3

2. Product Code Information

| | | | | | | | | | | | | | | | | | |
|---|---|---|---|---|---|---|---|---|----|----|----|----|----|----|----|----|----|
| 1 | 2 | 3 | 4 | 5 | 6 | 7 | 8 | 9 | 10 | 11 | 12 | 13 | 14 | 15 | 16 | 17 | 18 |
| S | P | M | W | H | 2 | 3 | 2 | 6 | F | P | 5 | G | N | V | Y | S | 0 |

| Digit | PKG Information | Code | Specification |
|--|------------------------------|---|--|
| 1 2 3 | Samsung Package Middle Power | SPM | Middle power |
| 4 5 | Color | WH | White |
| 6 | Product Version | 2 | Zenerless |
| 7 8 9 | Form Factor | 326 | 3.0 x 3.0 x 0.65 mm; 2 pads |
| 10 | Sorting Current | F | 150 mA |
| 11 | Chromaticity Coordinates | P | MacAdam |
| 12 | CRI | 5 | Min. 80 |
| 13 14 | Forward Voltage (V) | GN 6.0~6.4 | Bin Code: AZ 6.0~6.1 A1 6.1~6.2 |
| 15 16 | CCT (K) | W☆ 2700 V☆ 3000 U☆ 3500 T☆ 4000 R☆ 5000 Q☆ 5700 P☆ 6500 | Bin Code: WN, WP, WQ, WR, WS, WT, WU VN, VP, VQ, VR, VS, VT, VU UN, UP, UQ, UR, US, UT, UU TN, TP, TQ, TR, TS, TT, TU RN, RP, RQ, RR, RS, RT, RU QN, QP, QQ, QR, QS, QT, QU PN, PP, PQ, PR, PS, PT, PU |
| ☆ : "0" (Whole Bin) or "Y"(Y Kitting) or "3"(MacAdam 3 step) | | | |
| 17 18 | Luminous Flux (lm) | S0 | Bin Code S0 |

a) Luminous Flux Bins($I_F = 150 \text{ mA}$, $T_s = 25^\circ\text{C}$)

| Nominal CCT (K) | CRI Min. | Product Code | Flux Bin | Flux Range (Φ_v , lm) |
|-----------------|----------|--------------------|----------|-----------------------------|
| 2700 | 80 | SPMWH2326FP5GNW☆S0 | S0 | 129 ~ 139 |
| 3000 | 80 | SPMWH2326FP5GNV☆S0 | S0 | 130 ~ 140 |
| 3500 | 80 | SPMWH2326FP5GNU☆S0 | S0 | 138 ~ 148 |
| 4000 | 80 | SPMWH2326FP5GNT☆S0 | S0 | 138 ~ 148 |
| 5000 | 80 | SPMWH2326FP5GNR☆S0 | S0 | 138 ~ 148 |
| 5700 | 80 | SPMWH2326FP5GNQ☆S0 | S0 | 138 ~ 148 |
| 6500 | 80 | SPMWH2326FP5GNP☆S0 | S0 | 136 ~ 146 |

Note: "☆" can be "0" (Whole bin), "3" (MacAdam 3-step), "Y" (Kitting).

b) Kitting Rule

1) Y Kitting Bin Concept

1. Under agreement between customer and SAMSUNG ELECTRONICS, SAMSUNG can supply kitting bin (Color).
2. A Chromaticity Coordinates of kitting bin is mixed by kitting procedure.(below kitting simulation)

[Kitting example]

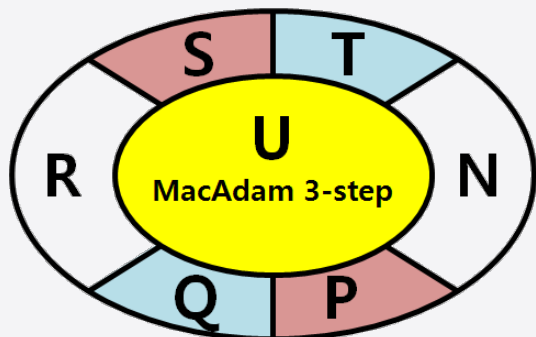

[Binning Information]

| Item | Bin #1 | Bin #2 |
|------|--------|--------|
| VF | AZ | AZ |
| | A1 | A1 |
| CIE | U | U |
| | N | R |
| | P | S |
| | Q | T |
| IV | S0 | S0 |

c) Color Bins ($I_F = 150 \text{ mA}$, $T_s = 25^\circ\text{C}$)

| min. CRI (Ra) | Nominal CCT (K) | Product Code | Color Rank | Chromaticity Bins | |
|---------------|-----------------|--------------------|------------|----------------------------|----------------------------|
| 2700 | | SPMWH2326FP5GNW0S0 | W0 | Whole bin | WN, WP, WQ, WR, WS, WT, WU |
| | | SPMWH2326FP5GNW3S0 | W3 | MacAdam 3-step ellipse bin | WU |
| | | SPMWH2326FP5GNWYS0 | WY | Y Kitting | WN, WP, WQ, WR, WS, WT, WU |
| 3000 | | SPMWH2326FP5GNV0S0 | V0 | Whole bin | VN, VP, VQ, VR, VS, VT, VU |
| | | SPMWH2326FP5GNV3S0 | V3 | MacAdam 3-step ellipse bin | VU |
| | | SPMWH2326FP5GNVYS0 | VY | Y Kitting | VN, VP, VQ, VR, VS, VT, VU |
| 3500 | | SPMWH2326FP5GNU0S0 | U0 | Whole bin | UN, UP, UQ, UR, US, UT, UU |
| | | SPMWH2326FP5GNU3S0 | U3 | MacAdam 3-step ellipse bin | UU |
| | | SPMWH2326FP5GNUYS0 | UY | Y Kitting | UN, UP, UQ, UR, US, UT, UU |
| 80 | 4000 | SPMWH2326FP5GNT0S0 | T0 | Whole bin | TN, TP, TQ, TR, TS, TT, TU |
| | | SPMWH2326FP5GNT3S0 | T3 | MacAdam 3-step ellipse bin | TU |
| | | SPMWH2326FP5GNTYS0 | TY | Y Kitting | TN, TP, TQ, TR, TS, TT, TU |
| 5000 | | SPMWH2326FP5GNR0S0 | R0 | Whole bin | RN, RP, RQ, RR, RS, RT, RU |
| | | SPMWH2326FP5GNR3S0 | R3 | MacAdam 3-step ellipse bin | RU |
| | | SPMWH2326FP5GNRYS0 | RY | Y Kitting | RN, RP, RQ, RR, RS, RT, RU |
| 5700 | | SPMWH2326FP5GNQ0S0 | Q0 | Whole bin | QN, QP, QQ, QR, QS, QT, QU |
| | | SPMWH2326FP5GNQ3S0 | Q3 | MacAdam 3-step ellipse bin | QU |
| | | SPMWH2326FP5GNQYS0 | QY | Y Kitting | QN, QP, QQ, QR, QS, QT, QU |
| 6500 | | SPMWH2326FP5GNP0S0 | P0 | Whole bin | PN, PP, PQ, PR, PS, PT, PU |
| | | SPMWH2326FP5GNP3S0 | P3 | MacAdam 3-step ellipse bin | PU |
| | | SPMWH2326FP5GNPYS0 | PY | Y Kitting | PN, PP, PQ, PR, PS, PT, PU |

d) Voltage Bins ($I_F = 150 \text{ mA}$, $T_s = 25^\circ\text{C}$)

| CRI (Ra) Min. | Nominal CCT (K) | Product Code | Voltage Rank | Voltage Bin | Voltage Range (V) |
|---------------|-----------------|--------------|--------------|-------------|-------------------|
| - | - | - | GN | AZ | 6.0 ~ 6.1 |
| - | - | - | - | A1 | 6.1 ~ 6.2 |

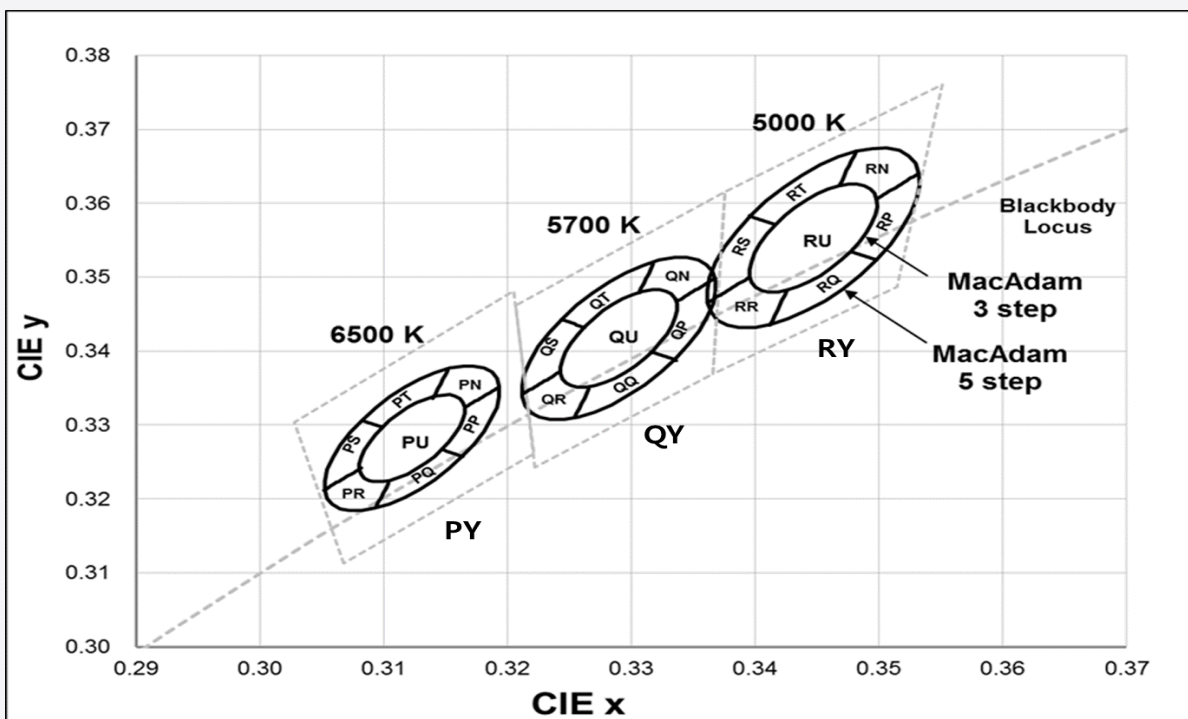
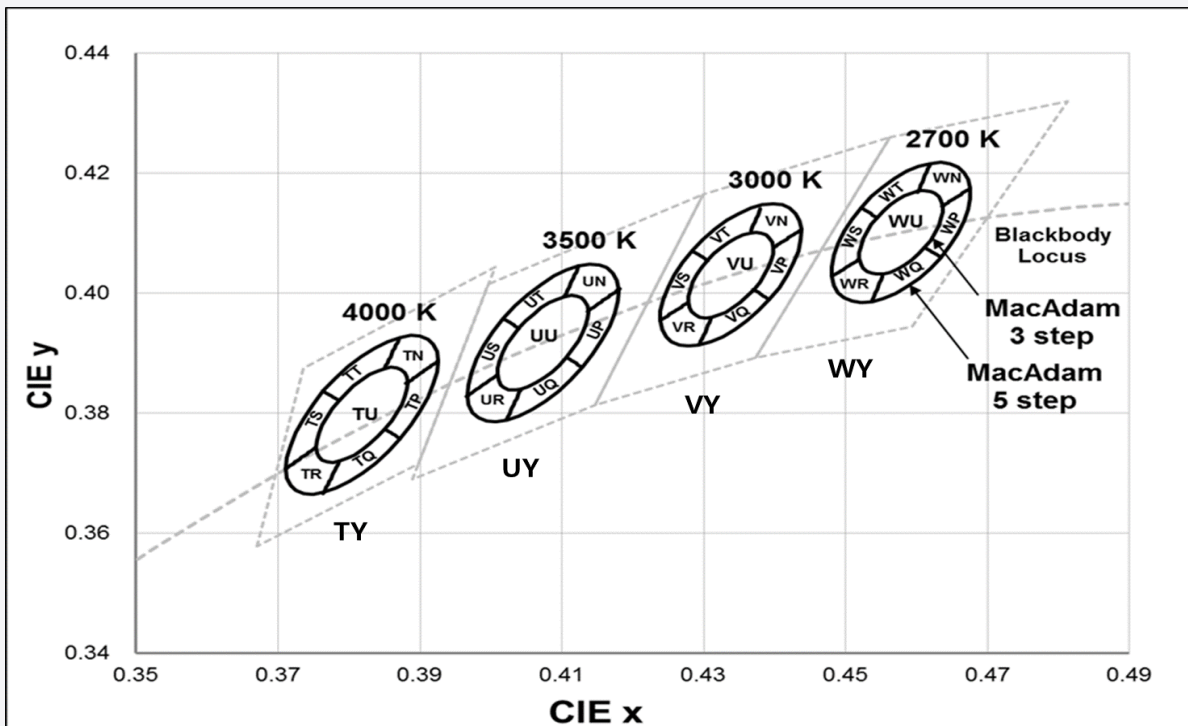
e) Chromaticity Region & Coordinates ($I_f = 150 \text{ mA}$, $T_s = 25^\circ\text{C}$)

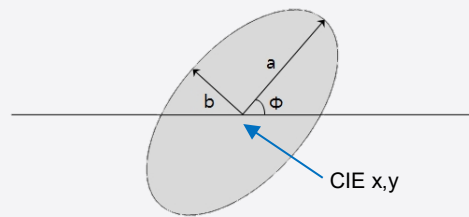
f) Chromaticity Region & Coordinates ($I_F = 150 \text{ mA}$, $T_s = 25^\circ\text{C}$)

| MacAdam | CCT (K) | Center point | | Major-axis | Minor-axis | Rotation |
|---------|---------|--------------|--------|------------|------------|----------|
| | | CIE x | CIE y | a | b | Φ |
| 3 step | 2700 | 0.4578 | 0.4101 | 0.0081 | 0.0042 | 53.70 |
| | 3000 | 0.4338 | 0.4030 | 0.0083 | 0.0041 | 53.22 |
| | 3500 | 0.4073 | 0.3917 | 0.0093 | 0.0041 | 54.00 |
| | 4000 | 0.3818 | 0.3797 | 0.0094 | 0.0040 | 53.72 |
| | 5000 | 0.3447 | 0.3553 | 0.0082 | 0.0035 | 59.62 |
| | 5700 | 0.3287 | 0.3417 | 0.0075 | 0.0032 | 59.10 |
| | 6500 | 0.3123 | 0.3282 | 0.0067 | 0.0029 | 58.57 |
| 5 step | 2700 | 0.4578 | 0.4101 | 0.0135 | 0.0070 | 53.70 |
| | 3000 | 0.4338 | 0.4030 | 0.0138 | 0.0068 | 53.22 |
| | 3500 | 0.4073 | 0.3917 | 0.0155 | 0.0068 | 54.00 |
| | 4000 | 0.3818 | 0.3797 | 0.0157 | 0.0067 | 53.72 |
| | 5000 | 0.3447 | 0.3553 | 0.0137 | 0.0058 | 59.62 |
| | 5700 | 0.3287 | 0.3417 | 0.0125 | 0.0053 | 59.10 |
| | 6500 | 0.3123 | 0.3282 | 0.0112 | 0.0048 | 58.57 |

Note: Samsung maintains measurement tolerance of: $C_x, C_y = \pm 0.005$

g) Chromaticity Region & Coordinates

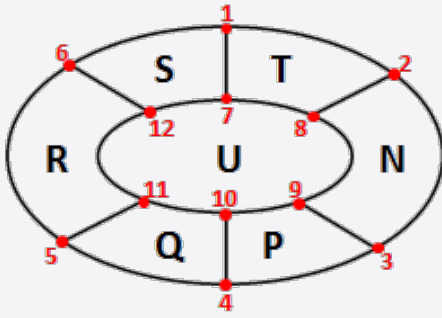

| Region | 2700K | | 3000K | | 3500K | | 4000K | |
|--------|--------|--------|--------|--------|--------|--------|--------|--------|
| | CIE x | CIE y | CIE x | CIE y | CIE x | CIE y | CIE x | CIE y |
| 1 | 0.4521 | 0.4142 | 0.4283 | 0.4071 | 0.4018 | 0.3957 | 0.3764 | 0.3837 |
| 2 | 0.4619 | 0.4216 | 0.4382 | 0.4146 | 0.4125 | 0.4046 | 0.3871 | 0.3926 |
| 3 | 0.4675 | 0.4175 | 0.4437 | 0.4105 | 0.4180 | 0.4005 | 0.3925 | 0.3887 |
| 4 | 0.4634 | 0.4059 | 0.4393 | 0.3989 | 0.4128 | 0.3877 | 0.3872 | 0.3758 |
| 5 | 0.4537 | 0.3986 | 0.4293 | 0.3913 | 0.4022 | 0.3788 | 0.3765 | 0.3668 |
| 6 | 0.4481 | 0.4028 | 0.4239 | 0.3954 | 0.3966 | 0.3828 | 0.3711 | 0.3707 |
| 7 | 0.4544 | 0.4126 | 0.4305 | 0.4054 | 0.4040 | 0.3941 | 0.3786 | 0.3821 |
| 8 | 0.4603 | 0.4170 | 0.4364 | 0.4100 | 0.4104 | 0.3994 | 0.3850 | 0.3874 |
| 9 | 0.4636 | 0.4145 | 0.4397 | 0.4075 | 0.4137 | 0.3970 | 0.3882 | 0.3851 |
| 10 | 0.4612 | 0.4076 | 0.4371 | 0.4005 | 0.4106 | 0.3893 | 0.3850 | 0.3773 |
| 11 | 0.4553 | 0.4032 | 0.4311 | 0.3960 | 0.4042 | 0.3840 | 0.3786 | 0.3720 |
| 12 | 0.4520 | 0.4057 | 0.4279 | 0.3984 | 0.4009 | 0.3864 | 0.3754 | 0.3743 |

| Region | 5000K | | 5700K | | 6500K | |
|--------|--------|--------|--------|--------|--------|--------|
| | CIE x | CIE y | CIE x | CIE y | CIE x | CIE y |
| 1 | 0.3397 | 0.3583 | 0.3242 | 0.3445 | 0.3082 | 0.3307 |
| 2 | 0.3482 | 0.3670 | 0.3320 | 0.3524 | 0.3153 | 0.3377 |
| 3 | 0.3532 | 0.3640 | 0.3365 | 0.3496 | 0.3194 | 0.3352 |
| 4 | 0.3497 | 0.3524 | 0.3333 | 0.3390 | 0.3164 | 0.3257 |
| 5 | 0.3412 | 0.3436 | 0.3254 | 0.3310 | 0.3093 | 0.3187 |
| 6 | 0.3362 | 0.3465 | 0.3209 | 0.3338 | 0.3052 | 0.3212 |
| 7 | 0.3417 | 0.3571 | 0.3260 | 0.3434 | 0.3098 | 0.3297 |
| 8 | 0.3468 | 0.3623 | 0.3307 | 0.3481 | 0.3141 | 0.3339 |
| 9 | 0.3498 | 0.3605 | 0.3334 | 0.3464 | 0.3166 | 0.3324 |
| 10 | 0.3477 | 0.3535 | 0.3314 | 0.3401 | 0.3148 | 0.3267 |
| 11 | 0.3426 | 0.3483 | 0.3267 | 0.3353 | 0.3105 | 0.3225 |
| 12 | 0.3396 | 0.3500 | 0.3240 | 0.3369 | 0.3080 | 0.3240 |

3. Typical Characteristics Graphs

a) Spectrum Distribution ($I_F = 150 \text{ mA}$, $T_s = 25 \text{ }^\circ\text{C}$)

CCT : 2700K (80 CRI)

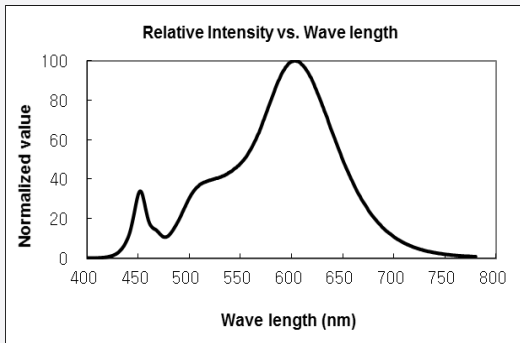

CCT : 3000K (80 CRI)

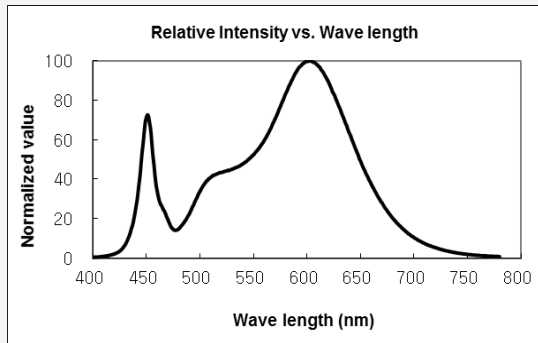

CCT : 3500K (80 CRI)

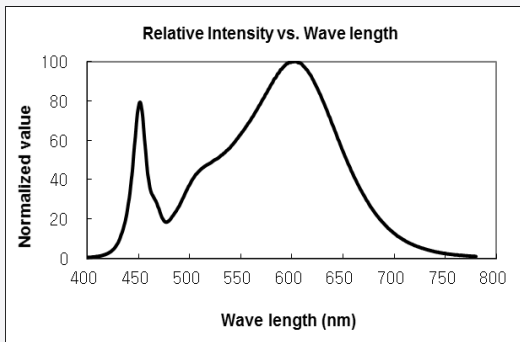

CCT : 4000K (80 CRI)

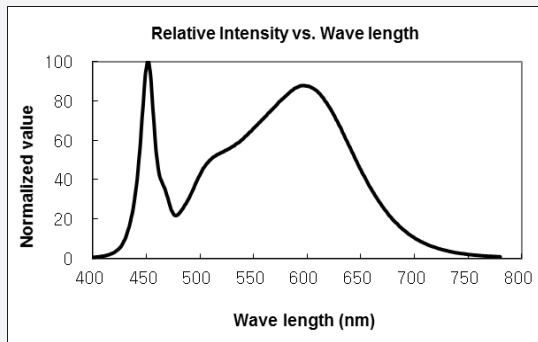

CCT : 5000K (80 CRI)

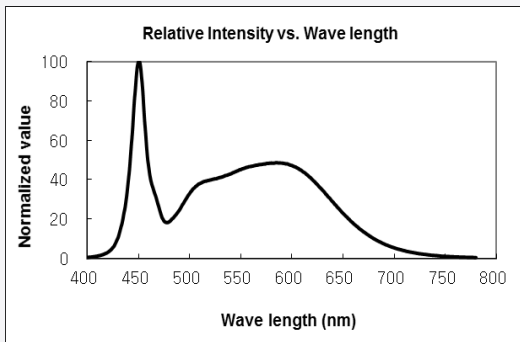

CCT : 5700K (80 CRI)

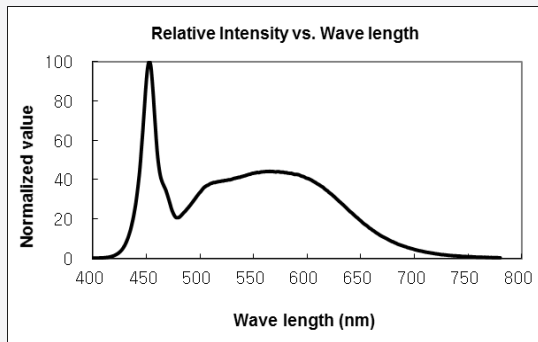

CCT : 6500K (80 CRI)

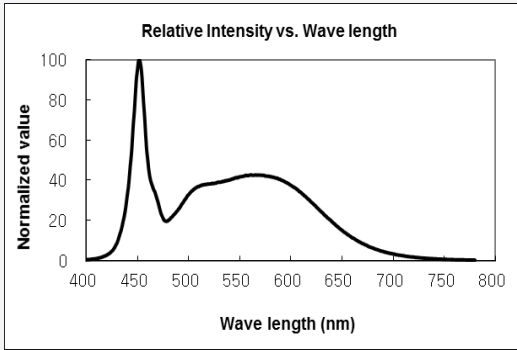

b) Forward Current Characteristics ($I_F = 150 \text{ mA}$, $T_s = 25 \text{ }^\circ\text{C}$)

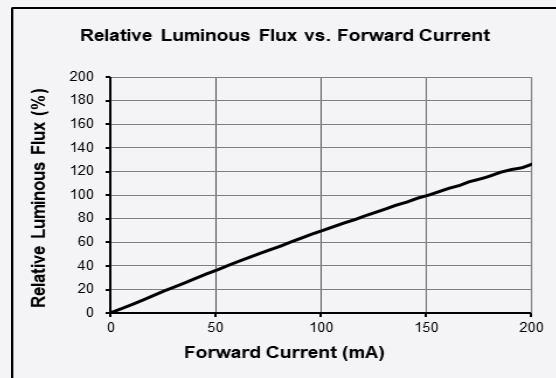
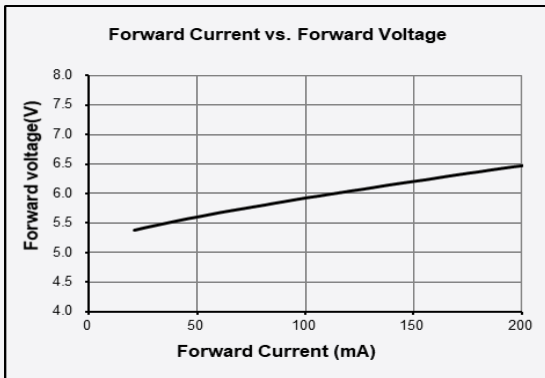

c) Temperature Characteristics ($I_F = 150 \text{ mA}$)

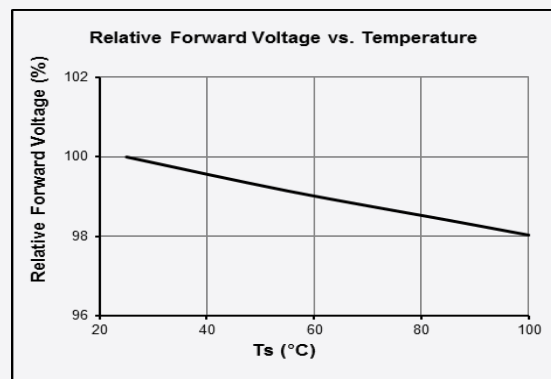
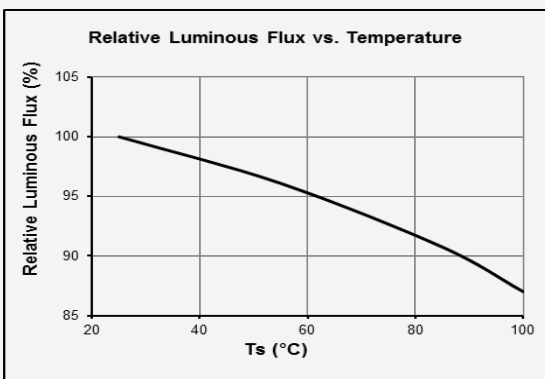

d) Color Shift Characteristics (Ts = 25 °C, IF = 150mA)

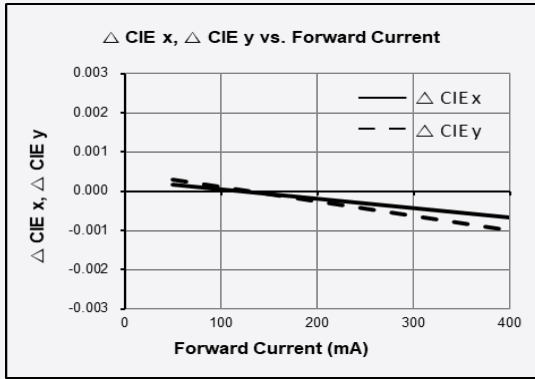
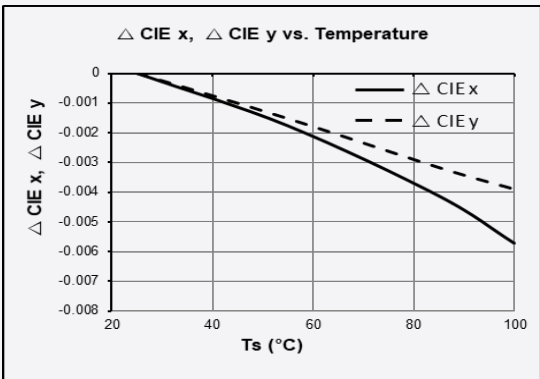

e) Derating Curve

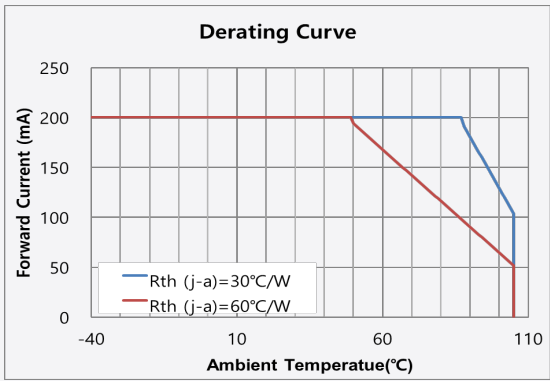

f) Beam Angle Characteristics (IF=150mA, Ts=25 °C)

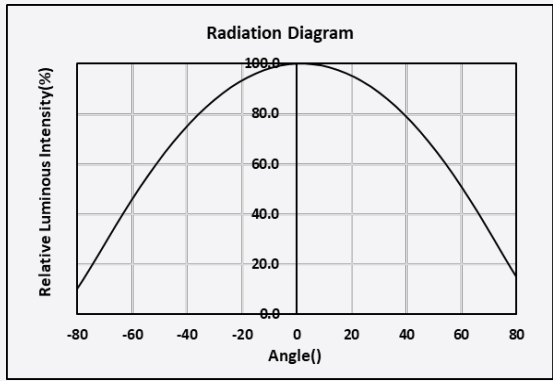

Note: All characteristics shown are for reference only.

Derating characteristics will meet the criteria as detailed in the Reliability section within this specification.

4. Outline Drawing & Dimension

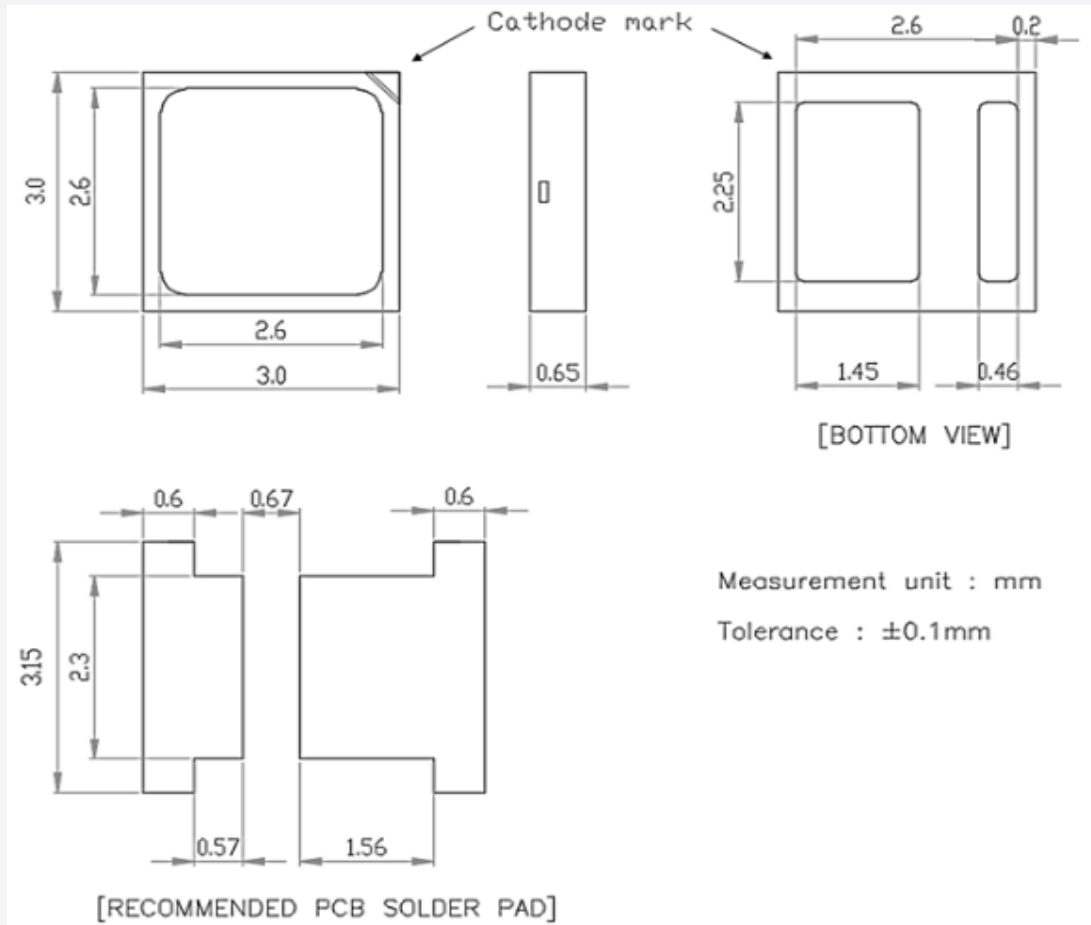

Notes:

- 1) This LED has built-in ESD protection device(s) connected in parallel to LED chip(s).
- 2) T_s point and measurement method:
 - ① Measure one point at the cathode pad, if necessary remove PSR of PCB to reach T_s point.
 - ② All pads must be soldered to the PCB to dissipate heat properly, otherwise the LED can be damaged.

Precautions:

- 1) Pressure on the LEDs will influence to the reliability of the LEDs. Precautions should be taken to avoid strong pressure on the LEDs. Do not put stress on the LEDs during heating.
- 2) Re-soldering should not be done after the LEDs have been soldered. If re-soldering is unavoidable, LED's characteristics should be carefully checked before and after such repair.
- 3) Do not stack assembled PCBs together. Since materials of LEDs is soft, abrasion between two PCB assembled with LED might cause catastrophic failure of the LEDs.

5. Reliability Test Items & Conditions

a) Test Items

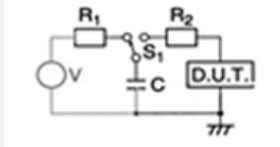
| Test Item | Test Condition | Test Hour / Cycle | Sample No. |
|-------------------------------------|---|-------------------|------------|
| High Temperature Life Test | 85 °C, DC 200 mA | 1000 h | 22 |
| High Temperature Humidity Life Test | 60 °C, 90 % RH, DC 200 mA | 1000 h | 22 |
| Low Temperature Life Test | -40 °C, DC 200 mA | 1000 h | 22 |
| Thermal Cycle | -45 °C / 15 min ↔ 125 °C / 15 min → Hot plate 180 °C | 500 cycles | 100 |
| High Temperature Storage | 120 °C | 1000 h | 11 |
| Low Temperature Storage | -40 °C | 1000 h | 11 |
| ESD (HBM) |  <p> R_1: 10 MΩ R_2: 1.5 kΩ C: 100 pF V: ± 2 kV </p> | 5 times | 30 |

b) Criteria for Judging the Damage

| Item | Symbol | Test Condition ($T_s = 25$ °C) | Limit | |
|-----------------|----------|------------------------------------|-------------------|-------------------|
| | | | Min | Max |
| Forward Voltage | V_F | $I_F = 150$ mA | Init. Value * 0.9 | Init. Value * 1.1 |
| Luminous Flux | Φ_v | $I_F = 150$ mA | Init. Value * 0.7 | Init. Value * 1.1 |

6. Soldering Conditions

a) Reflow Conditions (Pb free)

Reflow frequency: 2 times max.

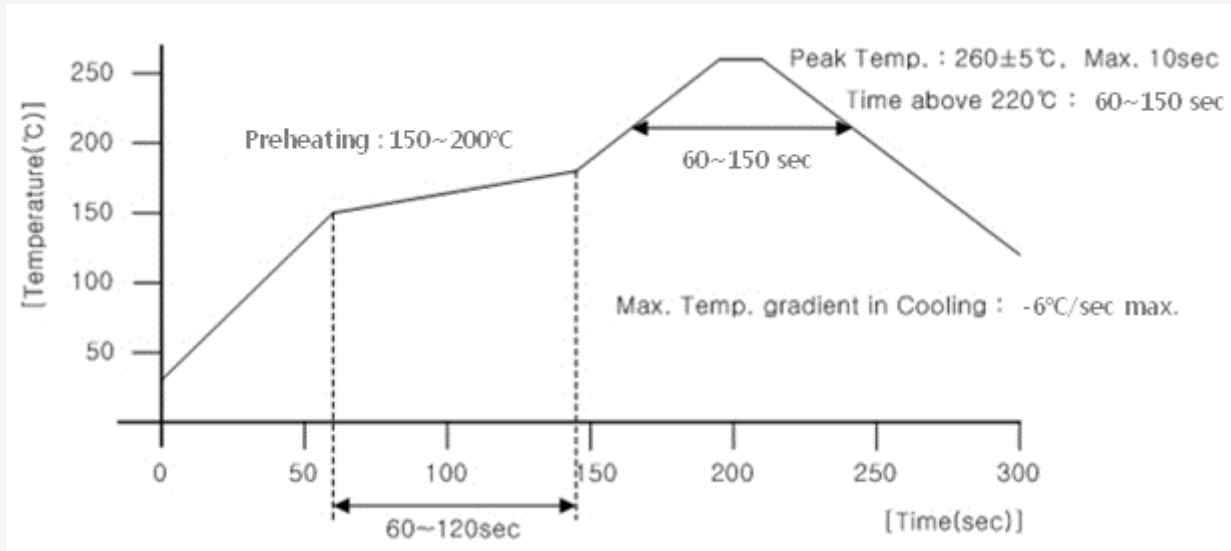

b) Manual Soldering Conditions

Not more than 5 seconds @ max. 300 °C, under soldering iron.

7. Tape & Reel

a) Taping Dimension

(unit: mm)

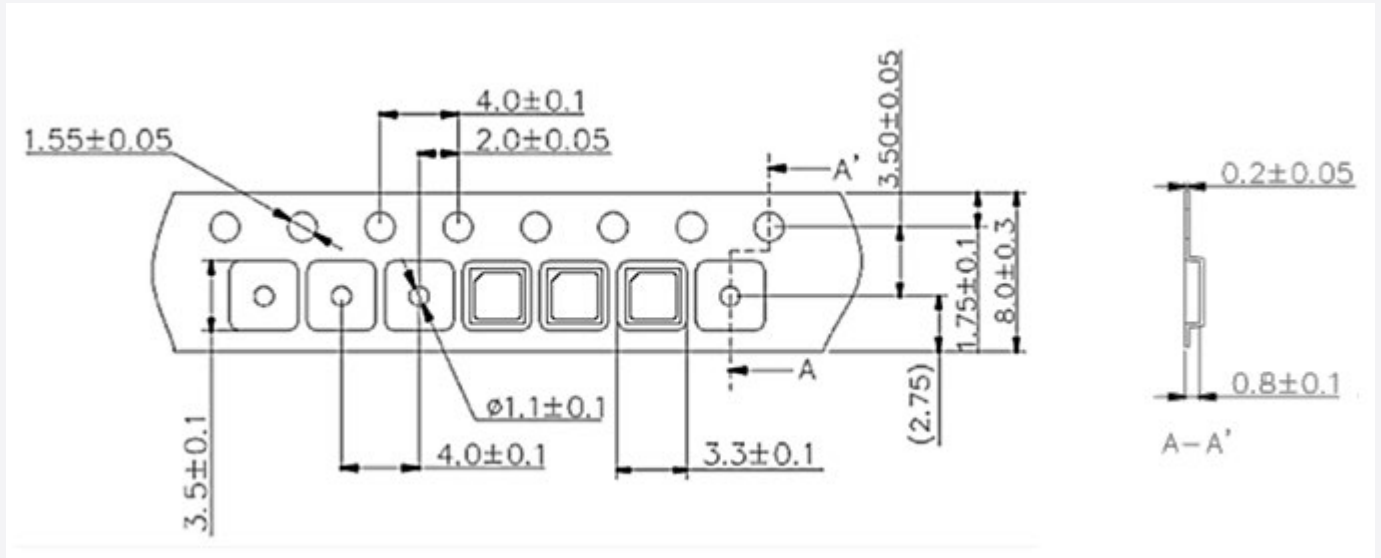

Taping Direction

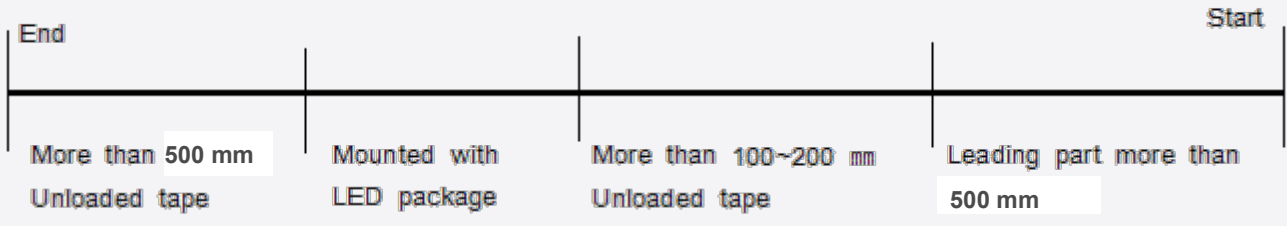

b) Reel Dimension

(unit: mm)

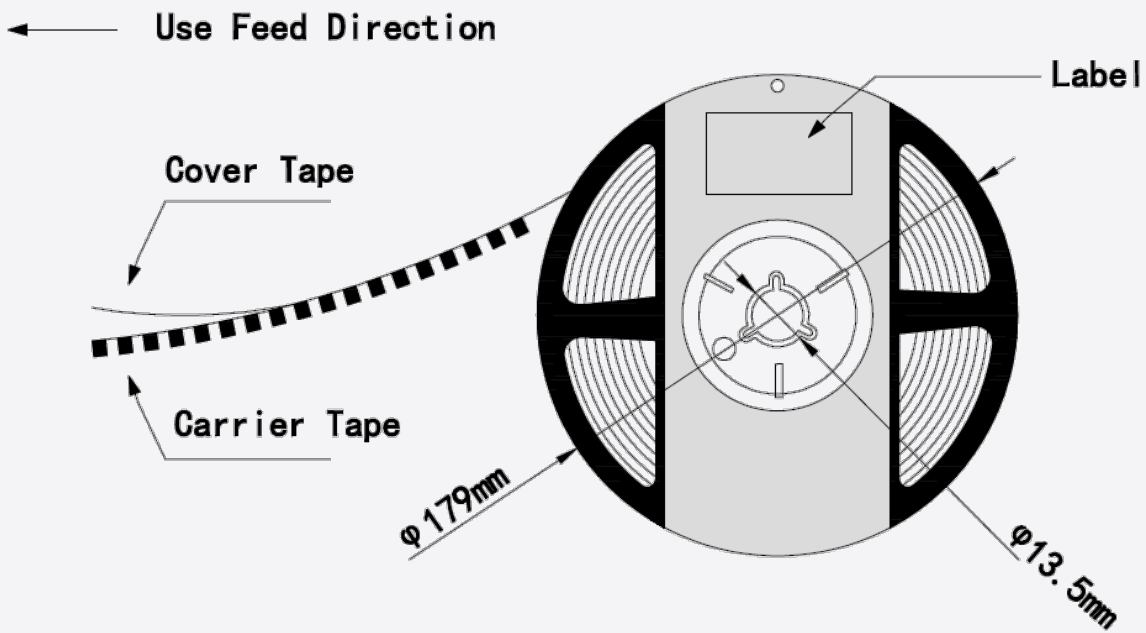

Notes:

- 1) Quantity: The quantity/reel is 4,000 pcs
- 2) Cumulative Tolerance: Cumulative tolerance / 10 pitches is ± 0.2 mm
- 3) Adhesion Strength of Cover Tape: Adhesion strength is 0.1-0.7 N when the cover tape is turned off from the carrier tape at 10° angle to the carrier tape
- 4) Packaging: P/N, Manufacturing data code no. and quantity are indicated on the aluminum packing bag

8. Label Structure

a) Label Structure

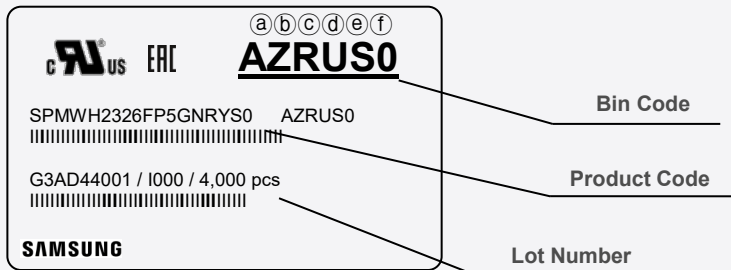

Note: Denoted bin code and product code above is only an example (see description on page 5)

Bin Code:

- ⒶⒷ: Forward Voltage bin (refer to page 7)
- ⒸⒹ: Chromaticity bin (refer to page 8-10)
- ⒺⒻ: Luminous Flux bin (refer to page 5)

b) Lot Number

The lot number is composed of the following characters:



①②③④⑤⑥⑦⑧⑨ / IⒶⒷⒸ / 4,000 pcs

- ①② : Production site (G3 : Shenzhen, China)
- ③ : Product state (A: Normal, B: Bulk, C: First Production, R: Reproduction, S: Sample)
- ④ : Year (C : 2018, D : 2019, E : 2020 ...)
- ⑤ : Month (1~9, A, B, C)
- ⑥ : Day (1~9, A, B~V)
- ⑦⑧⑨ : Serial number (001 ~ 999)
- ⒶⒷⒸ : Product serial number (001 ~ 999)

9. Packing Structure

a) Packing Process (The quantity of PKG on the Reel to be Max 4,000pcs)

Reel

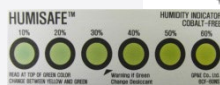
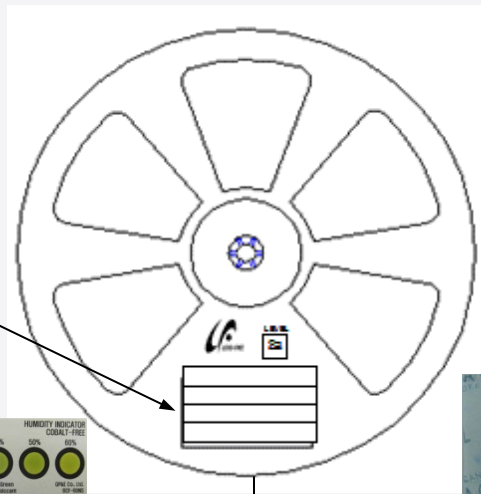
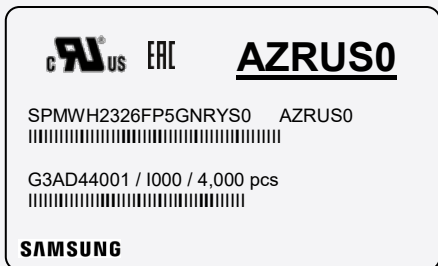

Aluminum Vinyl Packing Bag

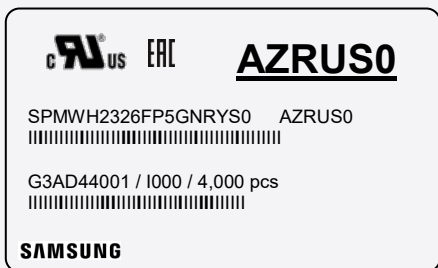

Outer Box

Material: Paper (SW3B(B))

| Type | Size (mm) | | | Note |
|----------|-----------|---------|---------|----------------|
| | L | W | H | |
| 7 inch L | 245 ± 5 | 220 ± 5 | 182 ± 5 | Up to 10 reels |
| 7 inch S | 245 ± 5 | 220 ± 5 | 86 ± 5 | Up to 5 reels |

① Side Label

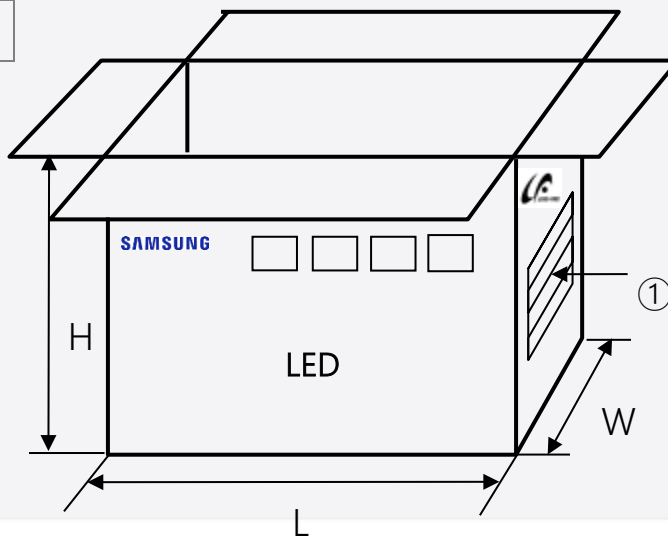
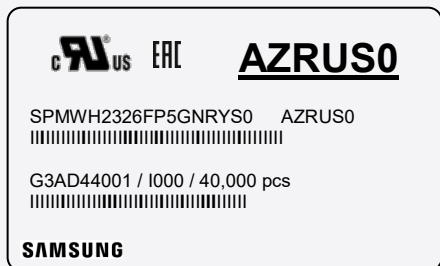

10. Precautions in Handling & Use

- 1) For over-current protection, users are recommended to apply resistors connected in series with the LEDs to mitigate sudden change of the forward current caused by shift of forward voltage.
- 2) This device should not be used in any type of fluid such as water, oil, organic solvent, etc. When cleaning is required, IPA is recommended as the cleaning agent. Some solvent-based cleaning agent may damage the silicone resins used in the device.
- 3) When the device is in operation, the forward current should be carefully determined considering the maximum ambient temperature and corresponding junction temperature.
- 4) LEDs must be stored in a clean environment. Shelf life of sealed bags is 12 months at temperature 0~40 °C, 0~90 % RH.
- 5) After storage bag is opened, device subjected to soldering, solder reflow, or other high temperature processes must be:
 - a. Mounted within 672 hours (28 days) at an assembly line with a condition of no more than 30 °C / 60 % RH*Note 1, or
 - b. Mounted within 24 hours (1 day) at an assembly line with a condition of more than 30 °C / 70 % RH*Note 2, or
 - c. Stored at <10 % RH.

*Note 1, 2: IPC/JEDEC J-STD-033A, Recommended Equivalent Total Floor Life Table

| Package Type and Body Thickness | Moisture Sensitivity Level | Maximum Percent Relative Humidity | | | | | | Temperature |
|---------------------------------|----------------------------|-----------------------------------|-----|-----|-----|-----|-----|-------------|
| | | 40% | 50% | 60% | 70% | 80% | 90% | |
| Body Thickness <2.1mm | Level 2a | ∞ | ∞ | 28 | 1 | 1 | 1 | 30°C |
| | | ∞ | ∞ | ∞ | 2 | 1 | 1 | 25°C |
| | | ∞ | ∞ | ∞ | 2 | 2 | 1 | 20°C |

- 6) Repack unused devices with anti-moisture packing, fold to close any opening and then store in a dry place.
- 7) Devices require baking before mounting, if humidity card reading is >60 % at 23 ± 5 °C.
- 8) Devices must be baked for 10~24 hours at 60 ± 5 °C, if baking is required.
- 9) The LEDs are sensitive to the static electricity and surge current. It is recommended to use a wrist band or anti-electrostatic glove when handling the LEDs. If voltage exceeding the absolute maximum rating is applied to LEDs, it may cause damage or even destruction to LED devices. Damaged LEDs may show some unusual characteristics such as increase in leakage current, lowered turn-on voltage, or abnormal lighting of LEDs at low current.
- 10) VOCs (Volatile Organic Compounds) can be generated from adhesives, flux, hardener or organic additives used in luminaires (fixtures). Transparent LED silicone encapsulant is permeable to those chemicals and they may lead to a discoloration of encapsulant when they exposed to heat or light. This phenomenon can cause a significant loss of light emitted (output) from the luminaires. In order to prevent these problems, we recommend users to know the physical properties of materials used in luminaires and they must be carefully selected.
- 11) Risk of sulfurization (or tarnishing)
The LED from Samsung uses a silver-plated lead frame and its surface color may change to black (or dark colored) when it is exposed to sulfur (S), chlorine (Cl) or other halogen compound. Sulfurization of lead frame may cause intensity degradation, change of chromaticity coordinates and, in extreme cases, open circuit. It requires caution. Due to possible sulfurization of lead frame, LED should not be used and stored together with oxidizing substances made of materials such as rubber, plain paper, lead solder cream, etc.

Legal and additional information.

[About Samsung Electronics Co., Ltd.](#)

Samsung inspires the world and shapes the future with transformative ideas and technologies.

The company is redefining the worlds of TVs, smartphones, wearable devices, tablets, digital appliances, network systems, and memory, system LSI, foundry and LED solutions. For the latest news, please visit the Samsung Newsroom at news.samsung.com.

Samsung provides limited warranty for its LED products, the full text of which is available at <https://www.samsung.com/led/support/warranties>

Copyright © 2020 Samsung Electronics Co., Ltd. All rights reserved.

Samsung is a registered trademark of Samsung Electronics Co., Ltd.

Specifications and designs are subject to change without notice. Non-metric weights and measurements are approximate. All data were deemed correct at time of creation. Samsung is not liable for errors or omissions. All brand, product, service names and logos are trademarks and/or registered trademarks of their respective owners and are hereby recognized and acknowledged.

Samsung Electronics Co., Ltd.

95, Samsung 2-ro

Giheung-gu

Yongin-si, Gyeonggi-do, 446-711

KOREA

www.samsungled.com

SAMSUNG