

Middle Power LED Series
3030

LM301B EVO

CRI 80

For Global



Features & Benefits

- 0.3 W class middle power LED
- Mold resin for high reliability
- Standard form factor for design flexibility (3.0 × 3.0 mm)

Table of Contents

1.	Characteristics	-----	3
2.	Product Code Information	-----	5
3.	Typical Characteristics Graphs	-----	13
4.	Outline Drawing & Dimension	-----	16
5.	Reliability Test Items & Conditions	-----	17
6.	Soldering Conditions	-----	18
7.	Tape & Reel	-----	19
8.	Label Structure	-----	21
9.	Packing Structure	-----	22
10.	Precautions in Handling & Use	-----	26

1. Characteristics

a) Absolute Maximum Rating

Item	Symbol	Rating	Unit	Condition
Ambient / Operating Temperature	T_a	-40 ~ +85	°C	-
Storage Temperature	T_{stg}	-40 ~ +120	°C	-
LED Junction Temperature	T_j	110	°C	-
Forward Current	I_F	200	mA	-
Pulse Forward Current	I_{FP}	300	mA	Duty 1/10, pulse width 10ms
Assembly Process Temperature	-	260 <10	°C s	-
ESD (HBM)	-	5	kV	-

b) Electro-optical Characteristics ($I_F = 65 \text{ mA}$, $T_s = 25^\circ\text{C}$)

Item	Unit	Rank	Bin	Min.	Typ.	Max.
Forward Voltage (V_F)	V	XA	AY	2.6	-	2.7
			AZ	2.7	-	2.8
			A1	2.8	-	2.9
Reverse Voltage (@ 5 mA)	V			0.7	-	1.2
Color Rendering Index (R_a)	-			80	-	-
Thermal Resistance (junction to solder point)	°C/W			-	7.5	-
Beam Angle	°			-	120	-

Note:

Samsung maintains measurement tolerance of: forward voltage = $\pm 0.1 \text{ V}$, luminous flux = $\pm 5 \%$, CRI = ± 3

c) Electro-optical Characteristics ($I_F = 65 \text{ mA}$, $T_s = 25^\circ\text{C}$)

Item	CRI	Nominal CCT (K)	Luminous Flux (lm)													
			35.5	36.0	36.5	37.0	37.5	38.0	38.5	39.0	39.5	40.0	40.5	41.0	41.5	42.0
Luminous Flux (Φ_v)	80	2700	35.5							38.5						
		3000		36.5								39.5				
		3500				37.5								40.5		
		4000										39.0				42.0
		5000										39.0				42.0
		5700										39.0				42.0
		6500								38.0						41.5

Note:

Samsung maintains measurement tolerance of: forward voltage = $\pm 0.1\text{V}$, luminous flux = $\pm 5\%$, CRI = ± 3

2. Product Code Information

1	2	3	4	5	6	7	8	9	10	11	12	13	14	15	16	17	18
S	P	M	W	H	D	3	2	A	M	V	5	X	A	R	0	S	U

Digit	PKG Information	Code	Specification
1 2 3	Samsung Package Middle Power	SPM	
4 5	Color	WH	White
6	Product Version	D	Dispensing
7 8 9	Form Factor	32A	3.0 x 3.0 x 0.80 mm; 2 pads;
10	Sorting Current (mA)	M	65 mA
11	Chromaticity Coordinates	V	ANSI Standard, MacAdam 3 step ellipse bin, MacAdam 5 step ellipse bin
12	CRI	5	Min. 80
13 14	Forward Voltage (V)	XA	2.6~2.9 Bin Code: AY 2.6~2.7 AZ 2.7~2.8 A1 2.8~2.9
15 16	Color bin	W●	2700 WA, WB, WC, WD, WE, WF, WG, WH, WJ, WK, WL, WM
		V●	3000 VA, VB, VC, VD, VE, VF, VG, VH, VJ, VK, VL, VM
		U●	3500 UA, UB, UC, UD, UE, UF, UG, UH, UJ, UK, UL, UM
		T●	4000 Bin Code: TA, TB, TC, TD, TE, TF, TG, TH, TJ, TK, TL, TM
		R●	5000 RA, RB, RC, RD, RE, RF, RG, RH, RJ, RK, RL, RM
		Q●	5700 QA, QB, QC, QD, QE, QF, QG, QH, QJ, QK, QL, QM
		P●	6500 PA, PB, PC, PD, PE, PF, PG, PH, PJ, PK, PL, PM
		●	: "0" (Whole bin) "3" (MacAdam 3-step ellipse bin) or "K" (K Kitting) or "S" (S Kitting)
17 18	Luminous Flux	SU	Bin Code: SU 35.5 ~ 42.0 (Different by nominal CCT)

a) Luminous Flux Bins($I_F = 65 \text{ mA}$, $T_s = 25^\circ\text{C}$)

CRI (Ra) Min.	Nominal CCT (K)	Product Code	Flux Bin	Flux Range (Φ_v , lm)
80	2700	SPMWHD32AMV5XAW●SU	SU	35.5 ~38.5
	3000	SPMWHD32AMV5XAV●SU	SU	36.5 ~39.5
	3500	SPMWHD32AMV5XAU●SU	SU	37.5 ~40.5
	4000	SPMWHD32AMV5XAT●SU	SU	39.0 ~42.0
	5000	SPMWHD32AMV5XAR●SU	SU	39.0 ~42.0
	5700	SPMWHD32AMV5XAQ●SU	SU	39.0 ~42.0
	6500	SPMWHD32AMV5XAP●SU	SU	38.0 ~41.0

Note:

● can be "0" (Whole bin), "3" (MacAdam 3-step ellipse bin), "S" (S Kitting) or "K" (K Kitting) of the color binning

b) Kitting Rule

1) S Kitting Bin Concept

1. Under agreement between customer and SAMSUNG ELECTRONICS, SAMSUNG can supply kitting bin (VF, Color, lm).
2. A forward voltage (VF) of kitting bin is combined by a pair of same VF rank such as (AY+AY), (AY+AZ), (AZ+AZ), (AZ+A1) or (A1+A1)
3. A Chromaticity Coordinates of kitting bin is mixed by kitting procedure.(below kitting simulation)
4. A luminous flux(lm) of kitting bin is combined by a pair of IV rank such as (SU+SU)

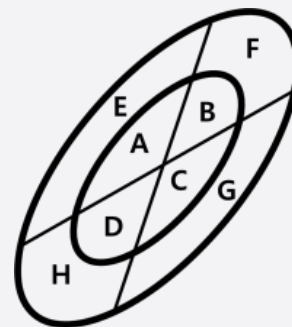

[Binning Information]

Item	Bin #1	Bin #2	Remark
VF	AY	AY	
	AY	AZ	
	AZ	AZ	
	AZ	A1	
	A1	A1	
CIE	A	G	
	C	E	
	D	F	
	B	H	
	E	G	
	F	H	
		MacA. 3step(A, B, C, D)	MacA. 3step(A, B, C, D)
IV	SU	SU	

2) K Kitting Bin Concept

1. Under agreement between customer and SAMSUNG ELECTRONICS, SAMSUNG can supply kitting bin (VF, Color, Im).
2. A forward voltage (VF) of kitting bin is combined by a pair of same VF rank such as (AY+AY), (AY+AZ), (AZ+AZ), (AZ+A1) or (A1+A1)
3. A Chromaticity Coordinates of kitting bin is mixed by kitting procedure.(below kitting simulation)
4. A luminous flux(lm) of kitting bin is combined by a pair of IV rank such (SU+SU)

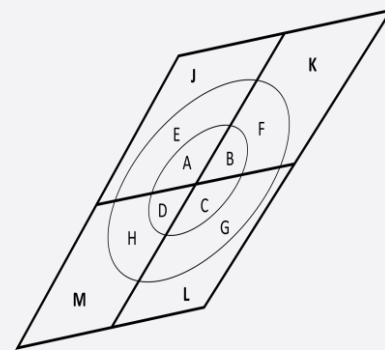

[Binning Information]

Item	Bin #1	Bin #2	Remark
VF	AY	AY	
	AY	AZ	
	AZ	AZ	
	AZ	A1	
	A1	A1	
CIE	H	K	
	F	M	
	E	L	
	G	J	
	F	H	
	MacA. 3step(A, B, C, D)	MacA. 3step(A, B, C, D)	
IV	SU	SU	

c) Color Bins ($I_f = 65 \text{ mA}$, $T_s = 25^\circ\text{C}$)

min. CRI	Nominal CCT (K)	Product Code	Color Rank	Chromaticity Bins	
80	2700	SPMWHD32AMV5XAW0SU	W0	Whole bin	WA, WB, WC, WD, WE, WF, WG, WH, WJ, WK, WL, WM
		SPMWHD32AMV5XAW3SU	W3	MacAdam 3-step ellipse bin	WA, WB, WC, WD
		SPMWHD32AMV5XAWSSU	WS	S Kitting	WA, WB, WC, WD, WE, WF, WG, WH
		SPMWHD32AMV5XAWKSU	WK	K Kitting	WA, WB, WC, WD, WE, WF, WG, WH, WJ, WK, WL, WM
	3000	SPMWHD32AMV5XAV0SU	V0	Whole bin	VA, VB, VC, VD, VE, VF, VG, VH, VJ, VK, VL, VM
		SPMWHD32AMV5XAV3SU	V3	MacAdam 3-step ellipse bin	VA, VB, VC, VD
		SPMWHD32AMV5XAVSSU	VS	S Kitting	VA, VB, VC, VD, VE, VF, VG, VH
		SPMWHD32AMV5XAVKSU	VK	K Kitting	VA, VB, VC, VD, VE, VF, VG, VH, VJ, VK, VL, VM
	3500	SPMWHD32AMV5XAU0SU	U0	Whole bin	UA, UB, UC, UD, UE, UF, UG, UH, UJ, UK, UL, UM
		SPMWHD32AMV5XAU3SU	U3	MacAdam 3-step ellipse bin	UA, UB, UC, UD
		SPMWHD32AMV5XAUSSU	US	S Kitting	UA, UB, UC, UD, UE, UF, UG, UH
		SPMWHD32AMV5XAUKSU	UK	K Kitting	UA, UB, UC, UD, UE, UF, UG, UH, UJ, UK, UL, UM
	4000	SPMWHD32AMV5XAT0SU	T0	Whole bin	TA, TB, TC, TD, TE, TF, TG, TH, TJ, TK, TL, TM
		SPMWHD32AMV5XAT3SU	T3	MacAdam 3-step ellipse bin	TA, TB, TC, TD
		SPMWHD32AMV5XATSSU	TS	S Kitting	TA, TB, TC, TD, TE, TF, TG, TH
		SPMWHD32AMV5XATKSU	TK	K Kitting	TA, TB, TC, TD, TE, TF, TG, TH, TJ, TK, TL, TM
	5000	SPMWHD32AMV5XAR0SU	R0	Whole bin	RA, RB, RC, RD, RE, RF, RG, RH, RJ,RK,RL,RM
		SPMWHD32AMV5XAR3SU	R3	MacAdam 3-step ellipse bin	RA, RB, RC, RD
		SPMWHD32AMV5XARSU	RS	S Kitting	RA, RB, RC, RD, RE, RF, RG, RH
		SPMWHD32AMV5XARKSU	RK	K Kitting	RA, RB, RC, RD, RE, RF, RG, RH, RJ,RK,RL,RM
	5700	SPMWHD32AMV5XAQ0SU	Q0	Whole bin	QA, QB, QC, QD, QE, QF, QG, QH, QJ,QK,QL,QM
		SPMWHD32AMV5XAQ3SU	Q3	MacAdam 3-step ellipse bin	QA, QB, QC, QD
		SPMWHD32AMV5XAQSSU	QS	S Kitting	QA, QB, QC, QD, QE, QF, QG, QH
		SPMWHD32AMV5XAQKSU	QK	K Kitting	QA, QB, QC, QD, QE, QF, QG, QH, QJ,QK,QL,QM
6500	SPMWHD32AMV5XAP0SU	P0	Whole bin	PA, PB, PC, PD, PE, PF, PG, PH, PJ,PK,PL,PM	
	SPMWHD32AMV5XAP3SU	P3	MacAdam 3-step ellipse bin	PA, PB, PC, PD	
	SPMWHD32AMV5XAPSSU	PS	S Kitting	PA, PB, PC, PD, PE, PF, PG, PH	
	SPMWHD32AMV5XAPKSU	PK	K Kitting	PA, PB, PC, PD, PE, PF, PG, PH, PJ,PK,PL,PM	

d) Voltage Bins ($I_f = 65 \text{ mA}$, $T_s = 25^\circ\text{C}$)

CRI (R_a) Min.	Nominal CCT (K)	Product Code	Voltage Rank	Voltage Bin	Voltage Range (V)
				AY	2.6 ~ 2.7
80	-	-	XA	AZ	2.7 ~ 2.8
				A1	2.8 ~ 2.9

e) Chromaticity Region & Coordinates ($I_f = 65 \text{ mA}$, $T_s = 25^\circ\text{C}$)

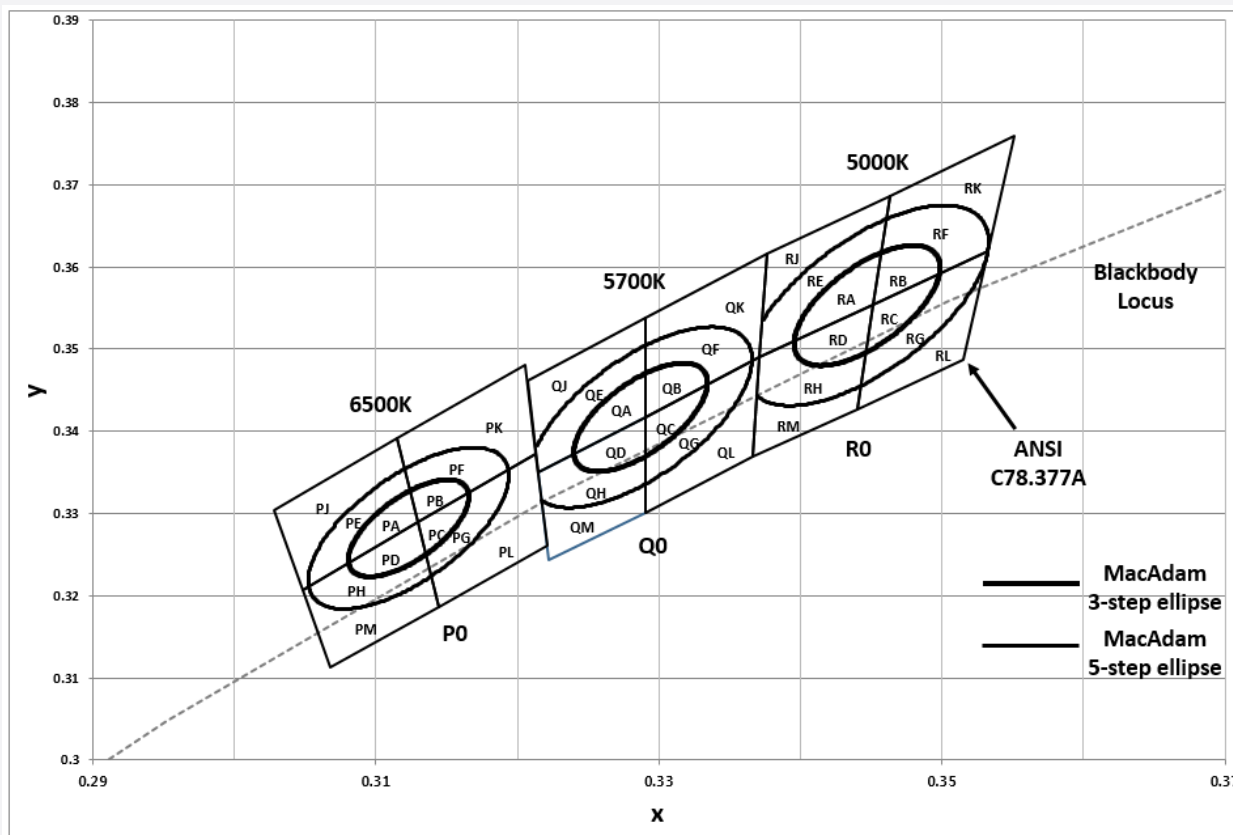
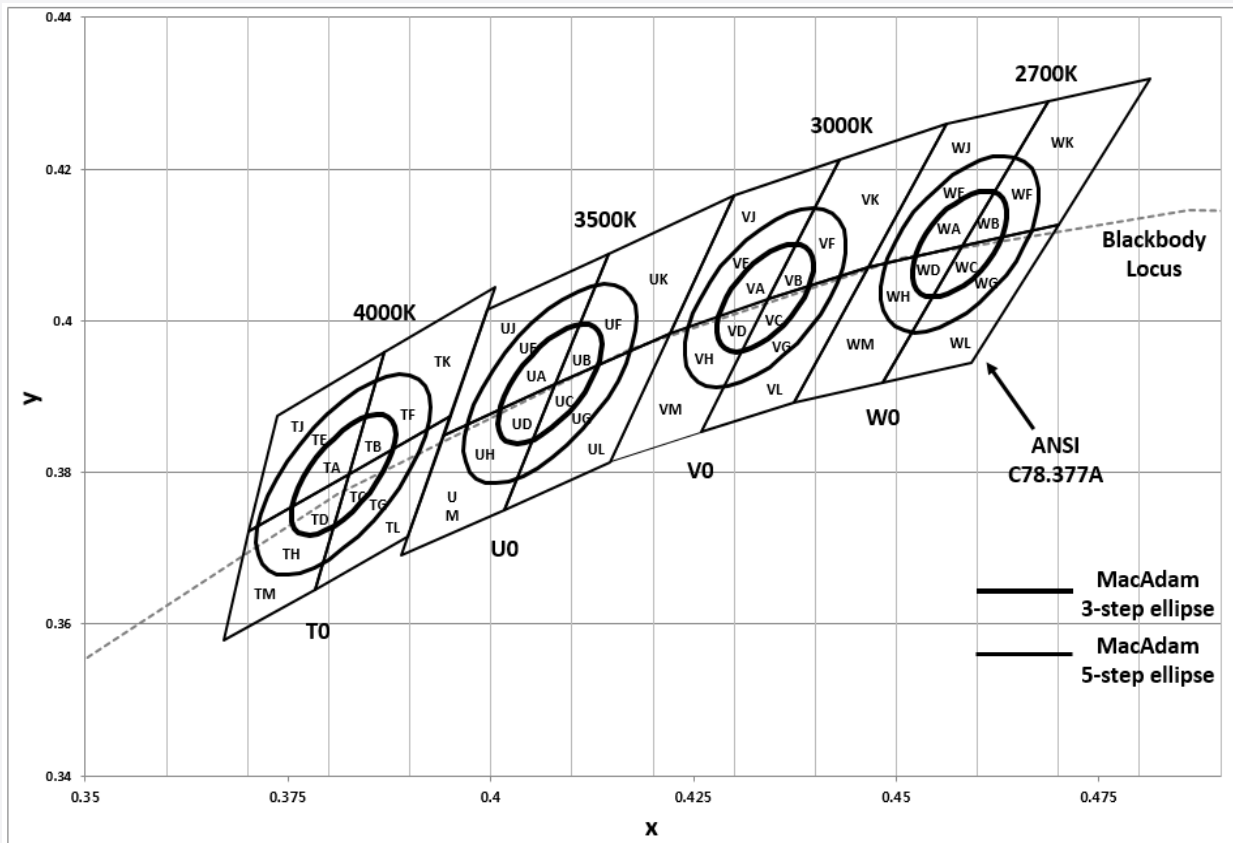

f) Chromaticity Region & Coordinates ($I_f = 65 \text{ mA}$, $T_s = 25^\circ\text{C}$)

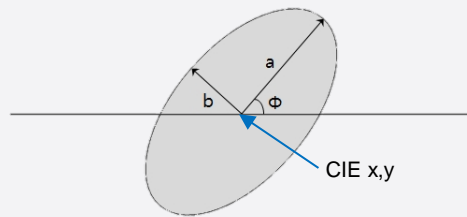

MacAdam Ellipse (W3, W5)					
Step	CIE x	CIE y	θ	a	b
3-step	0.4578	0.4101	53.70	0.0081	0.0042
5-step	0.4578	0.4101	53.70	0.01350	0.00700

MacAdam Ellipse (V3, V5)					
Step	CIE x	CIE y	θ	a	b
3-step	0.4338	0.4030	53.22	0.0083	0.0041
5-step	0.4338	0.4030	53.22	0.01390	0.00680

MacAdam Ellipse (T3, T5)					
Step	CIE x	CIE y	θ	a	b
3-step	0.3818	0.3797	53.72	0.00939	0.00402
5-step	0.3818	0.3797	53.72	0.01565	0.00670

MacAdam Ellipse (Q3, Q5)					
Step	CIE x	CIE y	θ	a	b
3-step	0.3287	0.3417	59.09	0.00746	0.00320
5-step	0.3287	0.3417	59.09	0.01243	0.00533

MacAdam Ellipse (U3, U5)					
Step	CIE x	CIE y	θ	a	b
3-step	0.4073	0.3917	54.00	0.00927	0.00414
5-step	0.4073	0.3917	54.00	0.01545	0.00690

MacAdam Ellipse (R3, R5)					
Step	CIE x	CIE y	θ	a	b
3-step	0.3447	0.3553	59.62	0.0082	0.0035
5-step	0.3447	0.3553	59.62	0.01370	0.00590

MacAdam Ellipse (P3, P5)					
Step	CIE x	CIE y	θ	a	b
3-step	0.3123	0.3282	58.57	0.00669	0.00285
5-step	0.3123	0.3282	58.57	0.01115	0.00475

Note:

Samsung maintains measurement tolerance of: $C_x, C_y = \pm 0.005$

3. Typical Characteristics Graphs

a) Spectrum Distribution ($I_f = 65 \text{ mA}$, $T_s = 25^\circ\text{C}$)

CCT : 2700K (80 CRI)

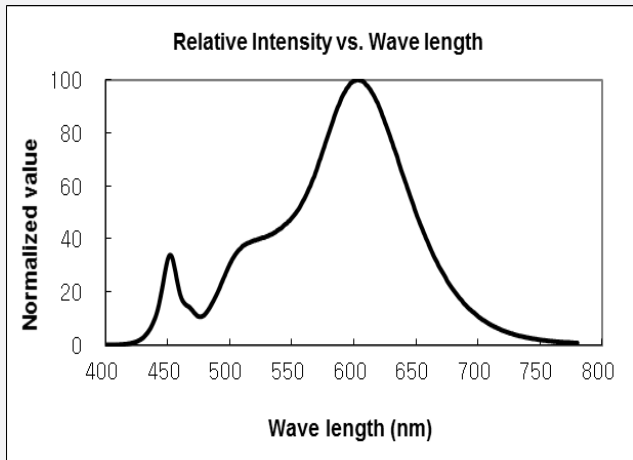

CCT : 3000K (80 CRI)

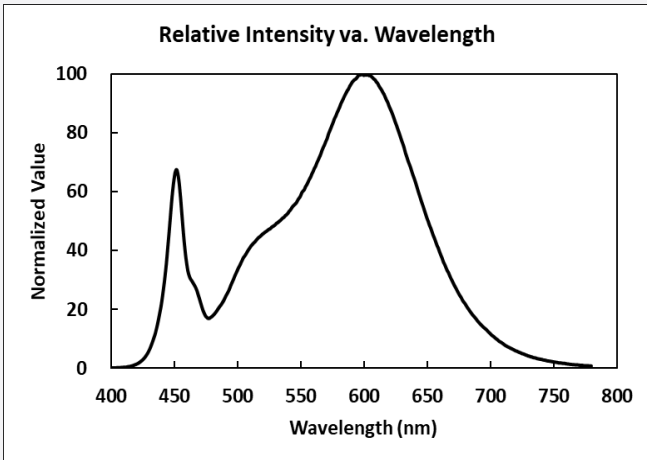

CCT : 3500K (80 CRI)

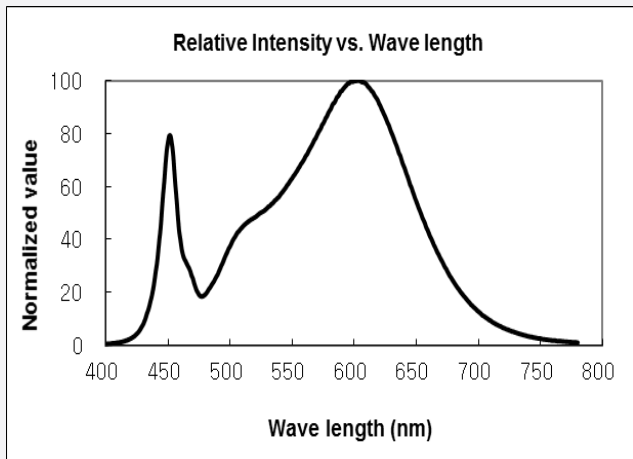

CCT : 4000K (80 CRI)

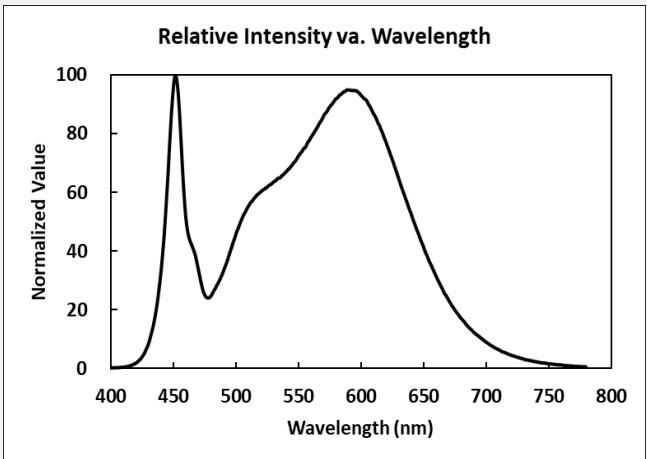

CCT : 5000K (80 CRI)

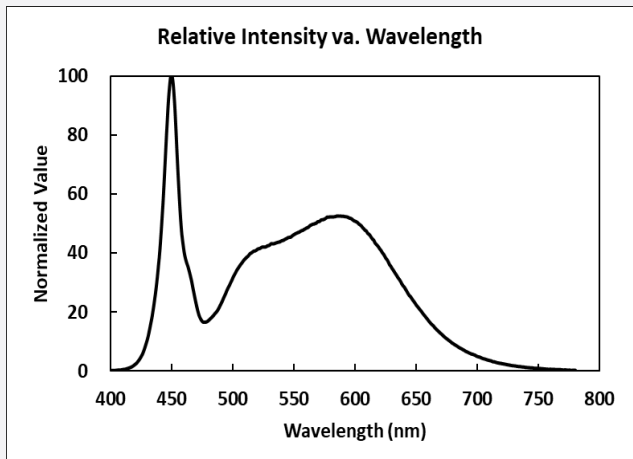

CCT : 5700K (80 CRI)

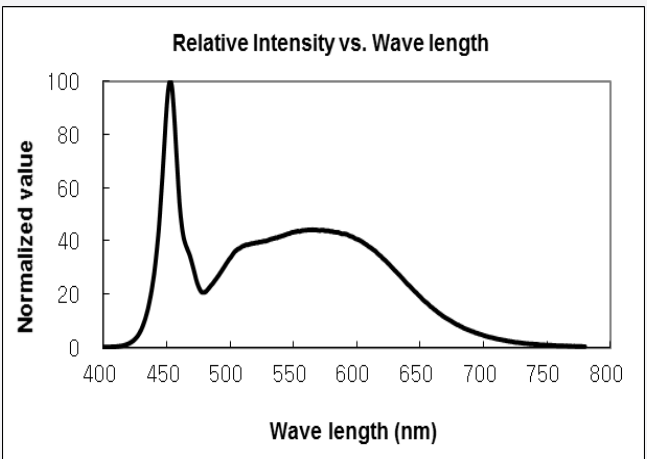

CCT : 6000K (80 CRI)

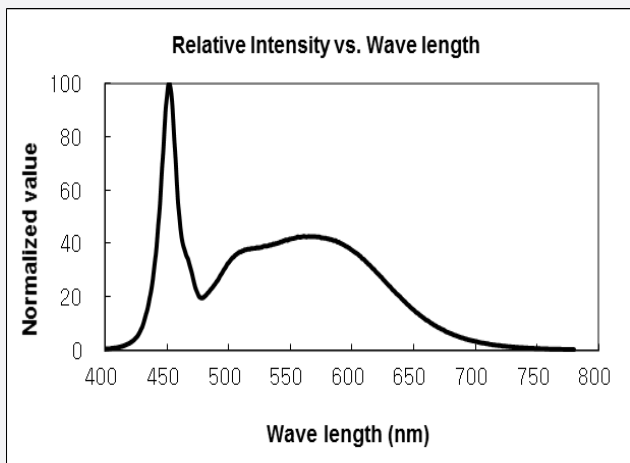

b) Forward Current Characteristics ($T_s = 25^\circ\text{C}$)

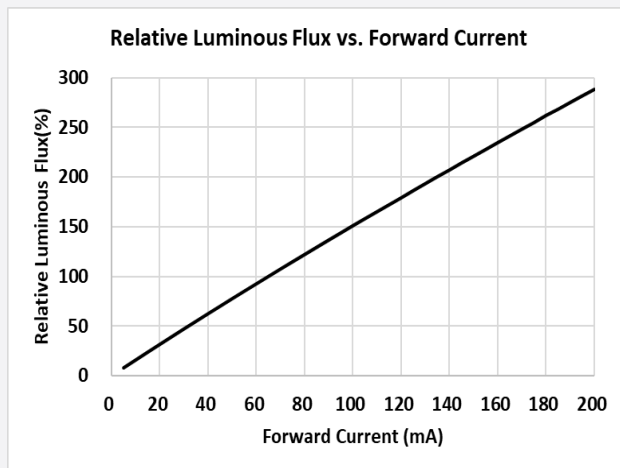
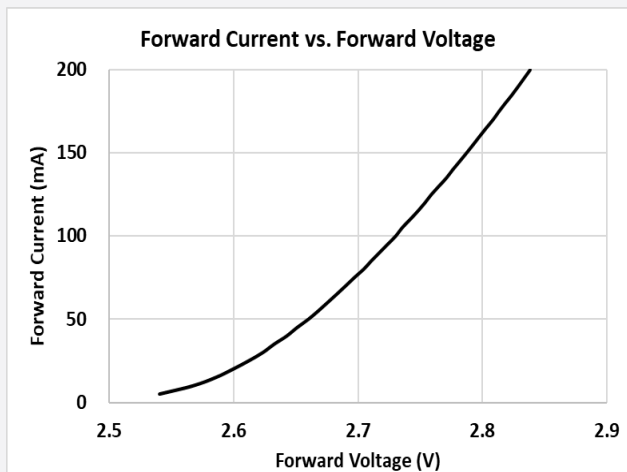

c) Temperature Characteristics ($I_F = 65 \text{ mA}$)

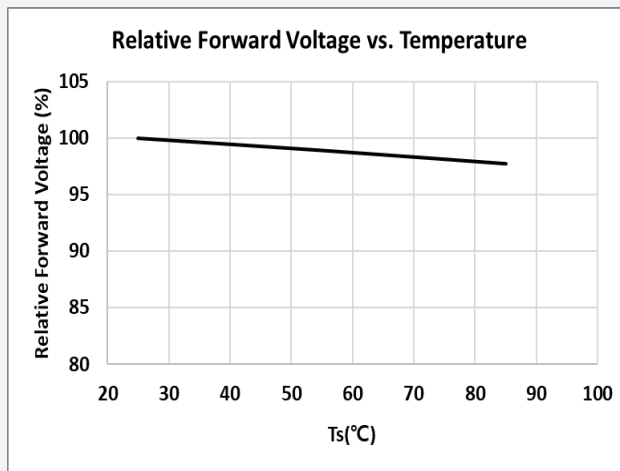
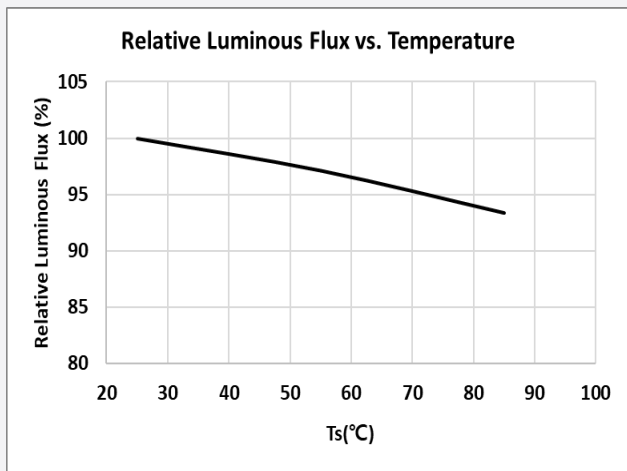

d) Color Shift Characteristics, $T_s = 25^\circ\text{C}$, $I_f = 65\text{ mA}$

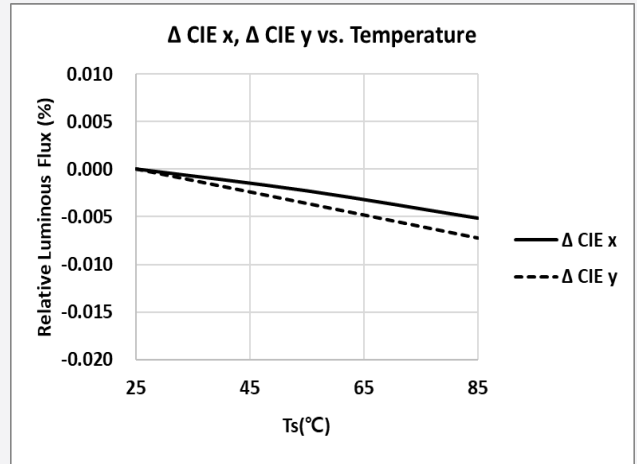
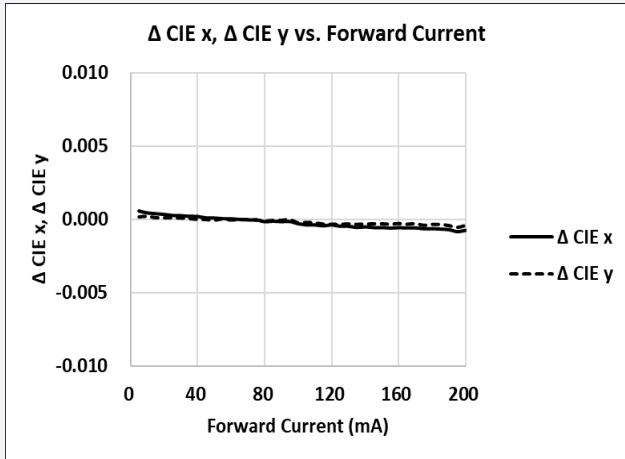

e) Derating Curve

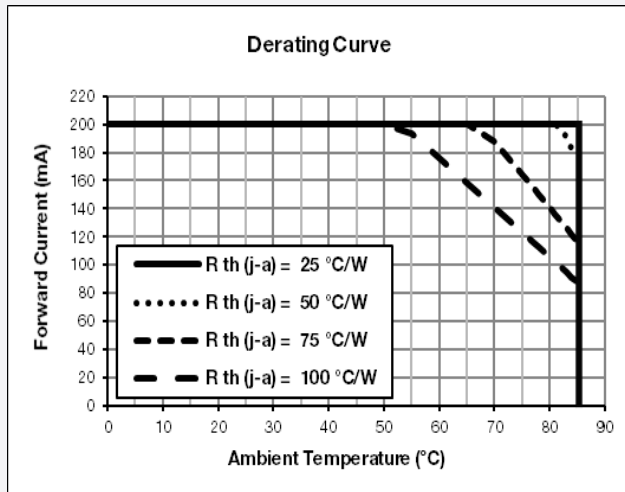

f) Beam Angle Characteristics ($T_s = 25^\circ\text{C}$, $I_f = 65\text{ mA}$)

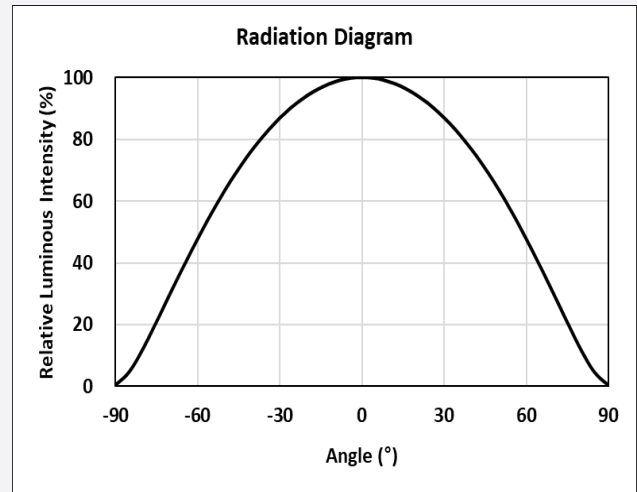

4. Outline Drawing & Dimension

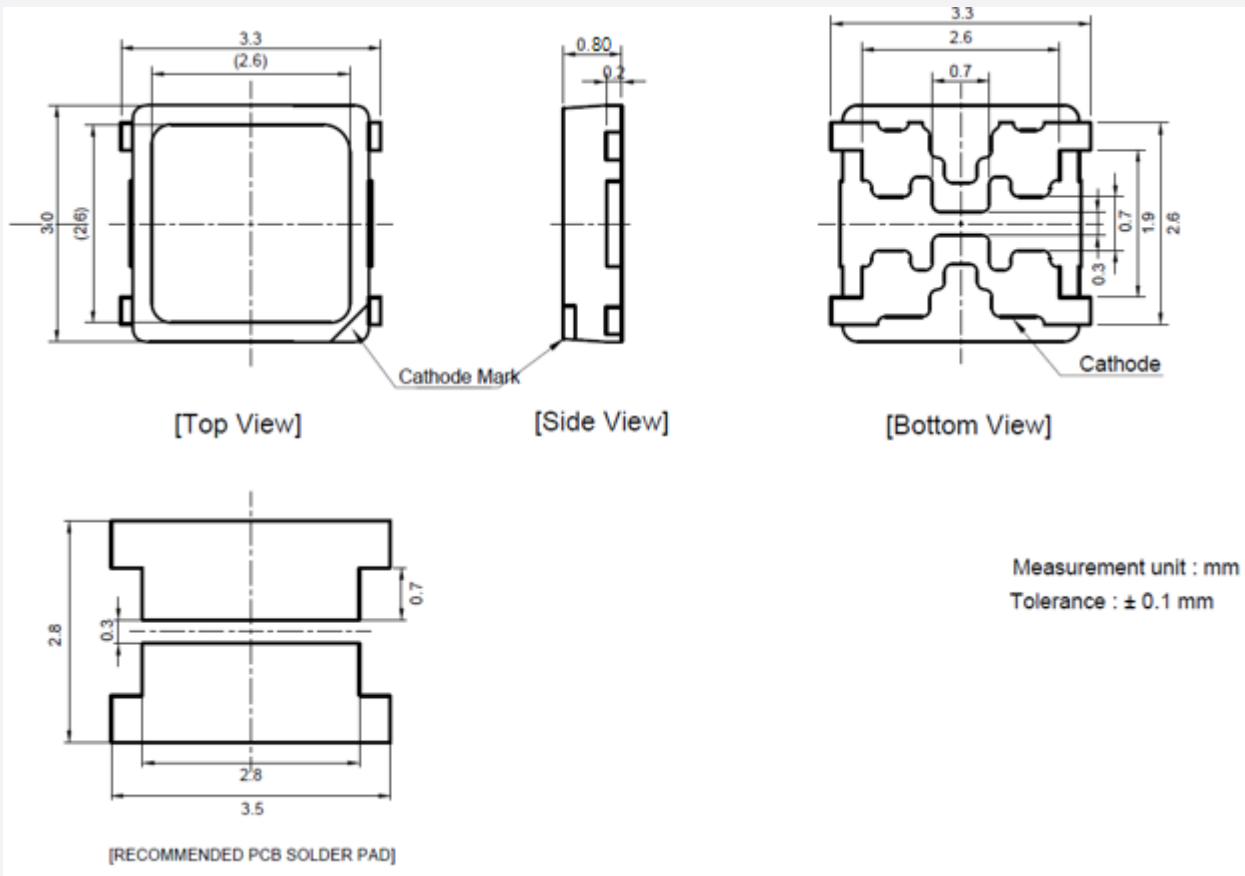

Notes:

- 1) This LED has built-in ESD protection device(s) connected in parallel to LED chip(s).
- 2) T_s point and measurement method:
 - ① Measure one point at the cathode pad, if necessary remove PSR of PCB to reach T_s point.
 - ② All pads must be soldered to the PCB to dissipate heat properly, otherwise the LED can be damaged.

Precautions:

- 1) Pressure on the LEDs will influence to the reliability of the LEDs. Precautions should be taken to avoid strong pressure on the LEDs. Do not put stress on the LEDs during heating.
- 2) Re-soldering should not be done after the LEDs have been soldered. If re-soldering is unavoidable, LED's characteristics should be carefully checked before and after such repair.
- 3) Do not stack assembled PCBs together. Since materials of LEDs is soft, abrasion between two PCB assembled with LED might cause catastrophic failure of the LEDs.

5. Reliability Test Items & Conditions

a) Test Items

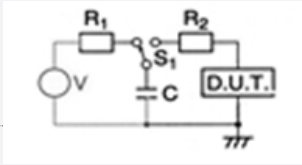
Test Item	Test Condition	Test Hour / Cycle	Sample No.
Room Temperature Life Test	25°C, DC 200 mA	1000 h	22
High Temperature Life Test	85°C, DC 200 mA	1000 h	22
High Temperature Humidity Life Test	85°C, 85 % RH, DC 200 mA	1000 h	22
Low Temperature Life Test	-40°C, DC 200 mA	1000 h	22
Powered Temperature Cycle Test	-40 °C ~ 85°C, each 10 min, On/Off 5min , Temp. Change Time 20min, DC 200 mA	100 cycles	22
Thermal Cycle	-45°C / 15 min ↔ 125°C / 15 min → Hot plate 180°C	500 cycles	100
High Temperature Storage	120°C	1000 h	11
Low Temperature Storage	-40°C	1000 h	11
ESD (HBM)		R ₁ : 10 MΩ R ₂ : 1.5 kΩ C: 100 pF V: ±5 kV	5 times 30
ESD (MM)		R ₁ : 10 MΩ R ₂ : 0 C: 200 pF V: ±0.5 kV	5 times 30
Vibration Test	20~2000~20 Hz, 200 m/s ² , sweep 4 min X, Y, Z 3 direction, each 1 cycle	4 cycles	11
Mechanical Shock Test	1500 g, 0.5 ms 3 shocks each X-Y-Z axis	5 cycles	11

b) Criteria for Judging the Damage

Item	Symbol	Test Condition (T _s = 25°C)	Limit	
			Min	Max
Forward Voltage	V _F	I _F = 65 mA	Init. Value * 0.9	Init. Value * 1.1
Luminous Flux	Φ _v	I _F = 65 mA	Init. Value * 0.7	Init. Value * 1.1

6. Soldering Conditions

a) Reflow Conditions (Pb free)

Reflow frequency: 2 times max.

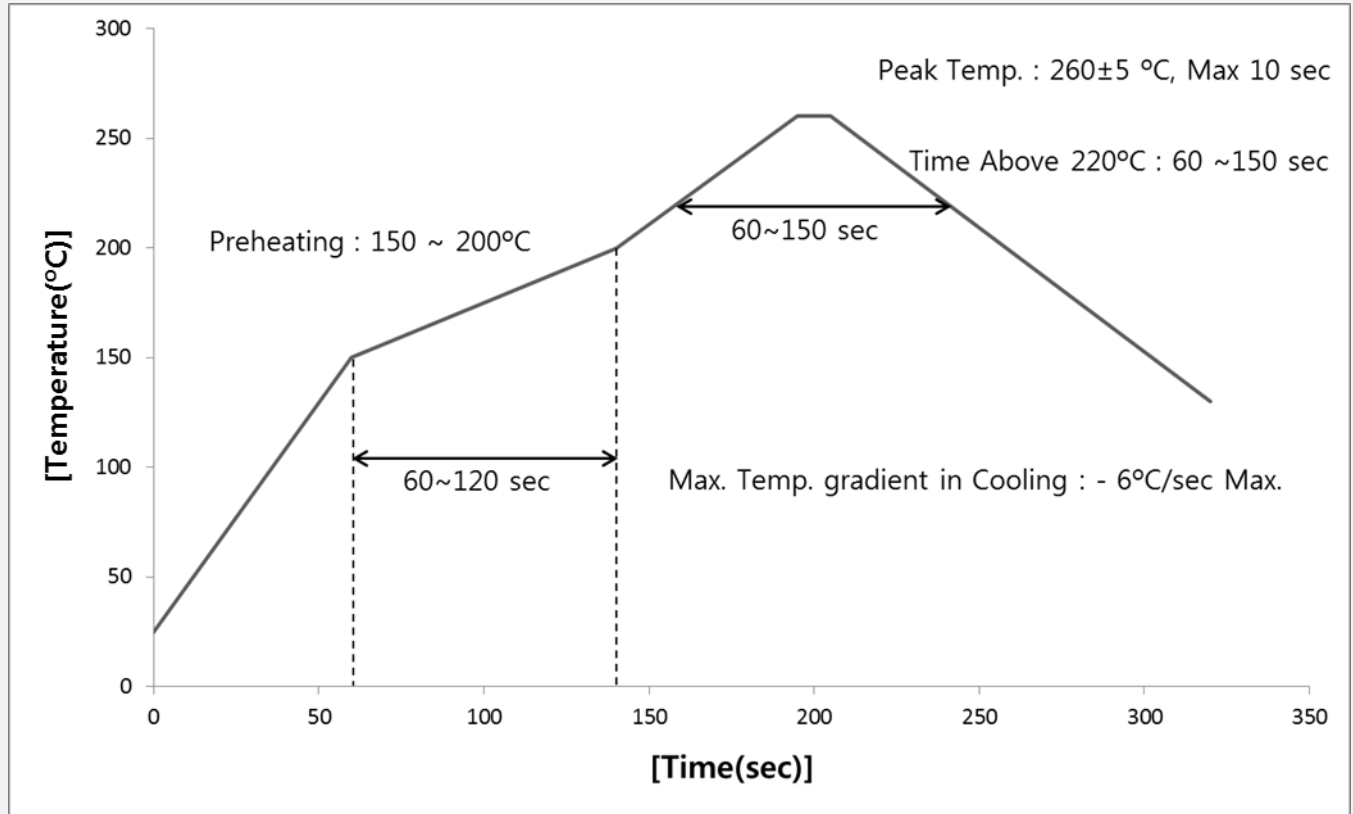

b) Manual Soldering Conditions

Not more than 5 seconds @ max. 300°C, under soldering iron.

7. Tape & Reel

a) Taping Dimension

(unit: mm)

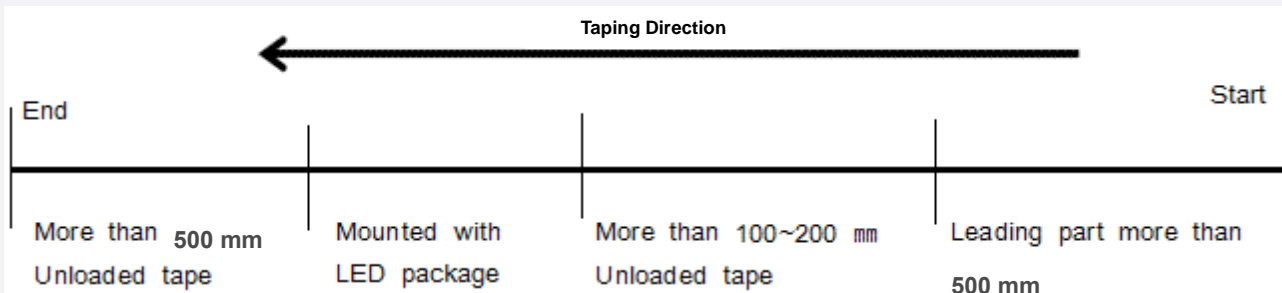
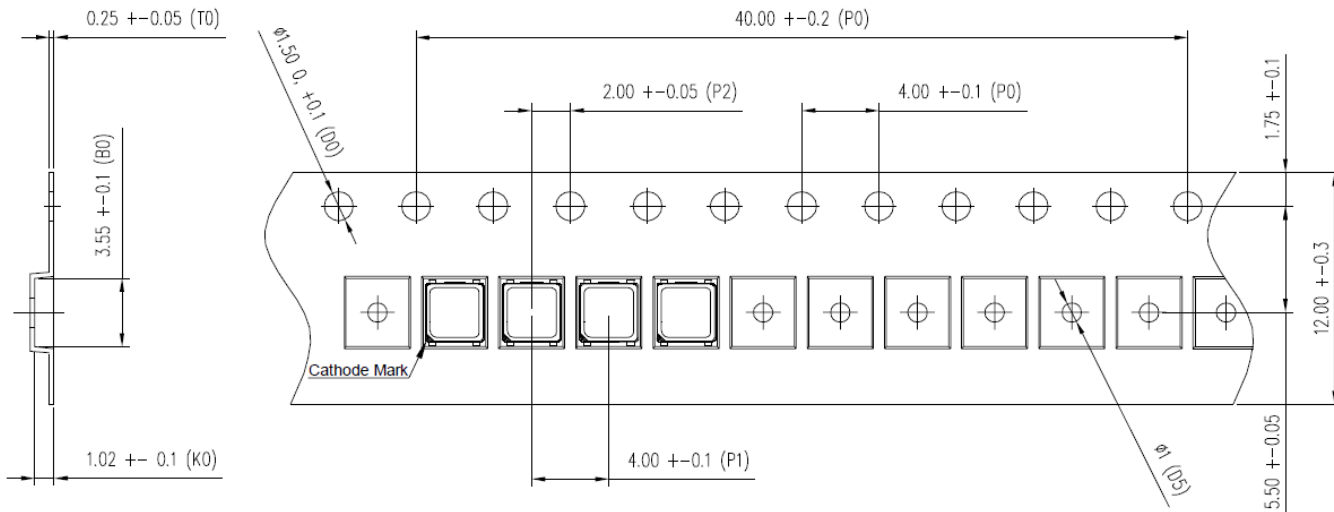

b) Reel Dimension

(unit: mm)

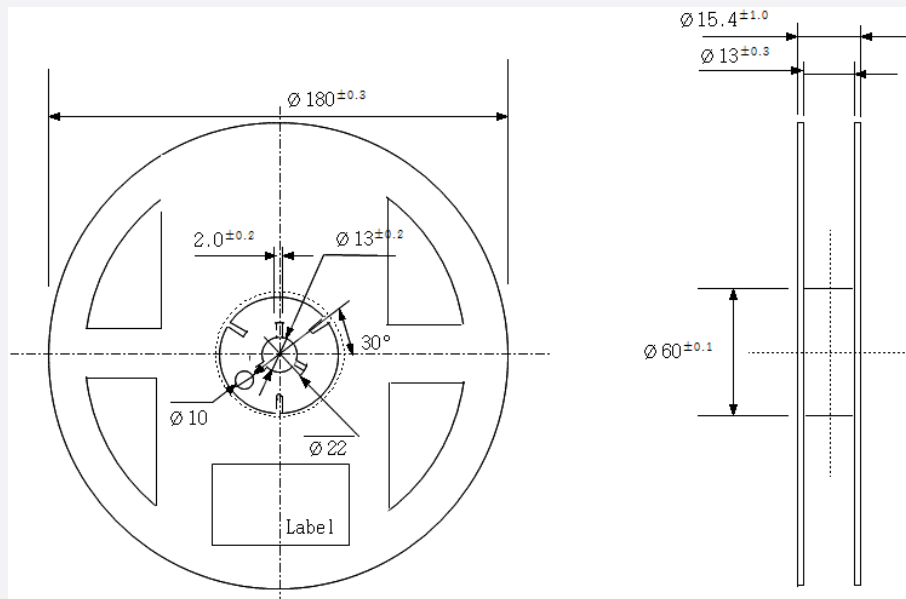
**Notes:**

- 1) Quantity: The quantity/reel is 4,000 pcs
- 2) Cumulative Tolerance: Cumulative tolerance / 10 pitches is ± 0.2 mm
- 3) Adhesion Strength of Cover Tape: Adhesion strength is 0.1-0.7 N when the cover tape is turned off from the carrier tape at 10° angle to the carrier tape
- 4) Packaging: P/N, Manufacturing data code no. and quantity are indicated on the aluminum packing bag

8. Label Structure

a) Label Structure

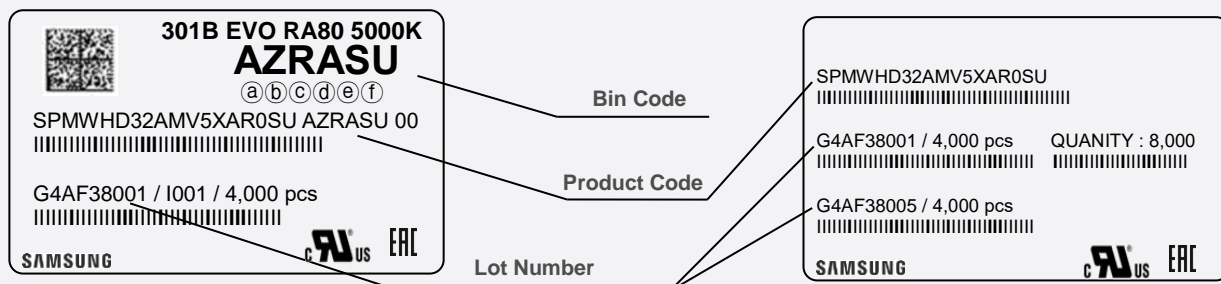

Note: Denoted bin code and product code above is only an example (see description on page 5)

Bin Code:

- ①②: Forward Voltage bin (refer to page 10)
- ③④: Chromaticity bin (refer to page 9-12)
- ⑤⑥: Luminous Flux bin (refer to page 4, 6)

b) Lot Number

The lot number is composed of the following characters:



①②③③②③④⑤⑥⑦⑧⑨ / I a b c / 4,000 pcs

- ①② : Production site (G4: Guangzhou, China, GR: Dongguan, China, EH : Hanoi, Vietnam)
- ③ : Product state (A: Normal, B: Bulk, C: First Production, R: Reproduction, S: Sample)
- ④ : Year (F : 2021, G : 2022, H : 2023, I : 2024 ...)
- ⑤ : Month (1~9, A, B, C)
- ⑥ : Day (1~9, A, B~V)
- ⑦⑧⑨ : Serial number (001 ~ 999)
- a b c : Reel number (001 ~ 999)

9. Packing Structure

a) Packing Process (The quantity of PKG on the Reel to be Max 4,000pcs)

Reel

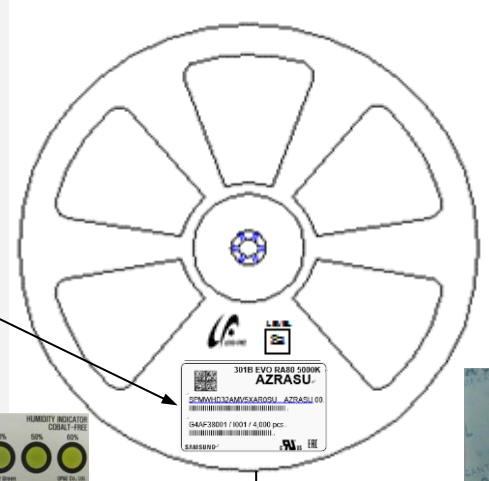

Aluminum Vinyl Packing Bag



Outer Box

Material: Paper (SW3B(B))

Type	Size (mm)			Note
	L	W	H	
7 inch L	245 ± 5	220 ± 5	182 ± 5	Up to 10 reels
7 inch S	245 ± 5	220 ± 5	86 ± 5	Up to 5 reels

① Side Label

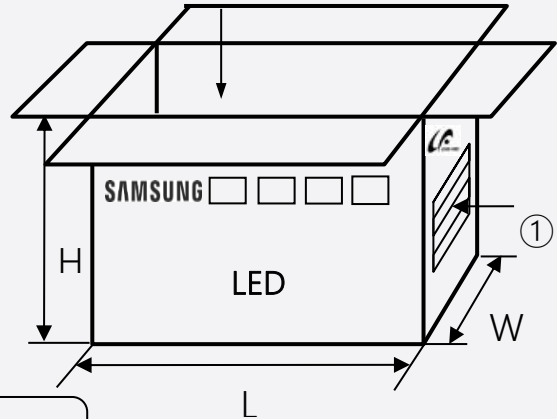

(1P) Supplier Part Number : SPMWHD32AMV5XAR0SU
 (33P) Bin Code / AZRASU
 (1T) Lot Number / G4AF38001

(Q) Quantity : 4,000
 (100) Data Code : 2110
 (4L) Country of Origin : CN

b) Packing Process for kitting (The quantity of PKG on the Reel to be Max 4,000pcs)

Reel

Kitting 'A'



301B EVO RA80 OOOOK
AY★DSU

SPMWH32AMV5XA★SSU AY★DSU 00

|||||

G4AF38001 / I001 / 4,000 pcs

|||||

SAMSUNG  

Kitting 'B'

301B EVO RA80 OOOOK
AY★FSU

SPMWH32AMV5XA★SSU AY★FSU 00

|||||

G4AF38005 / I001 / 4,000 pcs

|||||

SAMSUNG  

Aluminum Vinyl Packing Bag

Kitting 'A'

301B EVO RA80 OOOOK
AY★DSU

SPMWH32AMV5XA★SSU AY★DSU 00

|||||

G4AF38001 / I001 / 4,000 pcs

|||||

SAMSUNG  

Kitting 'B'

301B EVO RA80 OOOOK
AY★FSU

SPMWH32AMV5XA★SSU AY★FSU 00

|||||

G4AF38005 / I001 / 4,000 pcs

|||||

SAMSUNG  

Note: "★" can be Nominal CCT code.
: "OOOO" can be Nominal CCT.

Kitting 'B' (back Side)

SPMWH32AMV5XA★SS0

|||||

G4AF38001 / 4,000 pcs QUANTITY : 8,000

|||||

GLAF38005 / 4,000 pcs

|||||

SAMSUNG  

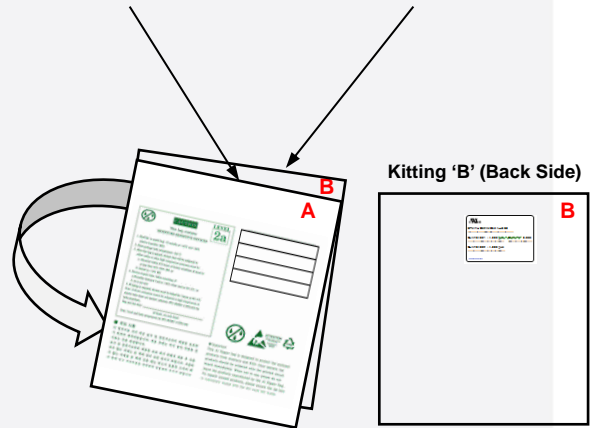
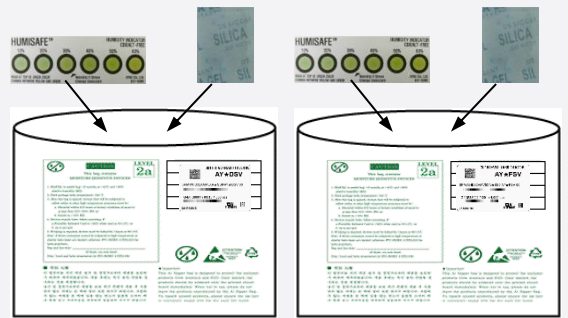
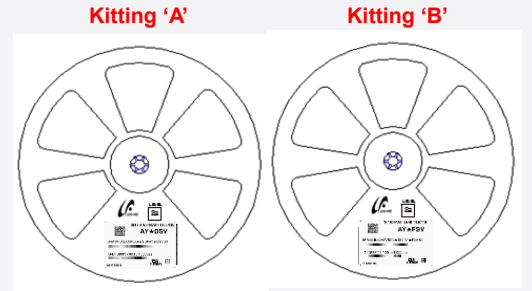

Next Page

b) Packing Process for kitting (The quantity of PKG on the Reel to be Max 4,000pcs)

Outer Box

Material: Paper (SW3B(B))

Type	Size (mm)			Note
	L	W	H	
7 inch L	245 ± 5	220 ± 5	182 ± 5	Up to 10 reels

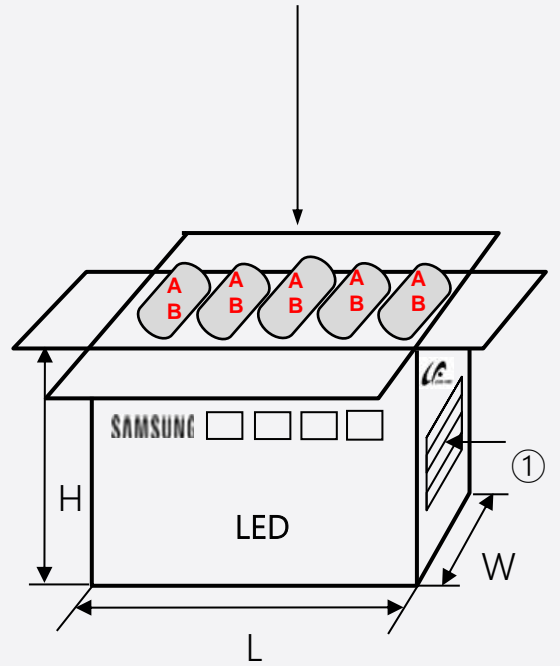



Kitting 'A'

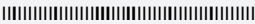

301B EVO RA80 OOOOK
AY★DSU

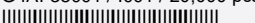
SPMWH32AMV5XA★SSU AY★DSU 00

G4AF38001 / I001 / 20,000 pcs

SAMSUNG [BOX Label]   

Kitting 'B'



301B EVO RA80 OOOOK
AY★FSU







SPMWH32AMV5XA★SSU AY★FSU 00

G4AF38005 / I001 / 20,000 pcs

SAMSUNG [BOX Label]   

Note: "★" can be Nominal CCT code.
: "OOOO" can be Nominal CCT.

(1P) Supplier Part Number : SPMWH32AMV5XA★SSU 	(Q) Quantity : 20,000 
(33P) Bin Code / AY★DSU 	(100) Data Code : 2110 
(1T) Lot Number / G4AF38001 	(4L) Country of Origin : CN 

(1P) Supplier Part Number : SPMWH32AMV5XA★SSU 	(Q) Quantity : 20,000 
(33P) Bin Code / AY★FSU 	(100) Data Code : 2110 
(1T) Lot Number / G4AF38005 	(4L) Country of Origin : CN 

Note: "★" can be Nominal CCT code.

c) Aluminum Vinyl Packing Bag



CAUTION

This bag contains
MOISTURE SENSITIVE DEVICES

LEVEL

2a



301B EVO RA80 5000K
AZRASU

SPMWH32AMV5XAR0SU AZRASU 00
|||||

G4AF38001 / I001 / 4,000 pcs
|||||

SAMSUNG

RoHS **REACH**

1. Shelf life in sealed bag: 12 months at <40°C and <90% relative humidity (RH)

2. Peak package body temperature: 240 °C

3. After this bag is opened, devices that will be subjected to reflow solder or other high temperature processes must be:

- a. Mounted within 672 hours at factory conditions of equal to or less than 30°C /60% RH, or
- b. Stored at <10% RH

4. Devices require bake, before mounting, if:

- a. Humidity Indicator Card is >60% when read at 23±5°C, or
- b. 2a is not met.

5. If baking is required, devices must be baked for 10 ~ 24 hours at 60±5°C

Note: If device containers cannot be subjected to high temperature or shorter bake times are desired, reference IPC/JEDEC J-STD-033 for bake procedure,

Bag seal due date: _____
(If blank, see code label)

Note: Level and body temperature by IPC/JEDEC J-STD-020



LEAD-FREE





ATTENTION
OBSERVE PRECAUTIONS
FOR HANDLING
ELECTROSTATIC
SENSITIVE
DEVICES



OTHER

■ 주의 사항

이 알루미늄 지퍼 백은 습기 및 정전기로부터 제품을 보호하기 위하여 제작되었습니다. 개봉 후에는 즉시 솔더 작업을 실시하는 것을 권장합니다.

습기 및 정전기로부터 제품을 보호 하기 위해서 개봉 후 사용하지 않는 자재는 본 팩에 넣어 보관 하시기 바랍니다. 사용하지 않는 자재를 본 팩에 넣을 때는 반드시 동봉된 드라이 팩과 함께 넣고 지퍼부분을 완전하게 밀봉하여 주시기 바랍니다.

■ Important

This Al Zipper bag is designed to protect the enclosed products from moisture and ESD. Once opened, the products should be soldered onto the printed circuit board immediately. When not in use, please do not leave the products unprotected by the Al Zipper Bag. To repack unused products., please ensure the zip-lock is completely sealed with the dry pack left inside.

d) Silica Gel & Humidity Indicator Card inside Aluminum Vinyl Bag

(This image is for reference only. Silica gel and humidity indicator shapes may be different.)



HUMISAFE™

10% 20% 30% 40% 50% 60%



READ AT TOP OF GREEN COLOR
CHANGE BETWEEN YELLOW AND GREEN

Warning if Green
Change Desiccant

**HUMIDITY INDICATOR
COBALT-FREE**

GP&E Co., Ltd.
6CF-60NS

10. Precautions in Handling & Use

- 1) For over-current protection, users are recommended to apply resistors connected in series with the LEDs to mitigate sudden change of the forward current caused by shift of forward voltage.
- 2) This device should not be used in any type of fluid such as water, oil, organic solvent, etc. When cleaning is required, IPA is recommended as the cleaning agent. Some solvent-based cleaning agent may damage the silicone resins used in the device.
- 3) When the device is in operation, the forward current should be carefully determined considering the maximum ambient temperature and corresponding junction temperature.
- 4) LEDs must be stored in a clean environment. Shelf life of sealed bags is 12 months at temperature 0~40 °C, 0~90 % RH.
- 5) After storage bag is opened, device subjected to soldering, solder reflow, or other high temperature processes must be:
 - a. Mounted within 672 hours (28 days) at an assembly line with a condition of no more than 30 °C / 60 % RH*^{Note 1}, or
 - b. Mounted within 24 hours (1 day) at an assembly line with a condition of more than 30 °C / 70 % RH*^{Note 2}, or
 - c. Stored at <10 % RH.

*Note 1, 2: IPC/JEDEC J-STD-033A, Recommended Equivalent Total Floor Life Table

Package Type and Body Thickness	Moisture Sensitivity Level	Maximum Percent Relative Humidity						Temperature
		40%	50%	60%	70%	80%	90%	
Body Thickness <2.1mm	Level 2a	∞	∞	28	1	1	1	30°C
		∞	∞	∞	2	1	1	25°C
		∞	∞	∞	2	2	1	20°C

- 6) Repack unused devices with anti-moisture packing, fold to close any opening and then store in a dry place.
- 7) Devices require baking before mounting, if humidity card reading is >60 % at 23 ± 5 °C.
- 8) Devices must be baked for 10~24 hours at 60 ± 5 °C, if baking is required.
- 9) The LEDs are sensitive to the static electricity and surge current. It is recommended to use a wrist band or anti-electrostatic glove when handling the LEDs. If voltage exceeding the absolute maximum rating is applied to LEDs, it may cause damage or even destruction to LED devices. Damaged LEDs may show some unusual characteristics such as increase in leakage current, lowered turn-on voltage, or abnormal lighting of LEDs at low current.
- 10) VOCs (Volatile Organic Compounds) can be generated from adhesives, flux, hardener or organic additives used in luminaires (fixtures). Transparent LED silicone encapsulant is permeable to those chemicals and they may lead to a discoloration of encapsulant when they exposed to heat or light. This phenomenon can cause a significant loss of light emitted (output) from the luminaires. In order to prevent these problems, we recommend users to know the physical properties of materials used in luminaires and they must be carefully selected.
- 11) Risk of sulfurization (or tarnishing)
 The LED from Samsung uses a silver-plated lead frame and its surface color may change to black (or dark colored) when it is exposed to sulfur (S), chlorine (Cl) or other halogen compound. Sulfurization of lead frame may cause intensity degradation, change of chromaticity coordinates and, in extreme cases, open circuit. It requires caution. Due to possible sulfurization of lead frame, LED should not be used and stored together with oxidizing substances made of materials such as rubber, plain paper, lead solder cream, etc.

Legal and additional information.

[About Samsung Electronics Co., Ltd.](#)

Samsung inspires the world and shapes the future with transformative ideas and technologies.

The company is redefining the worlds of TVs, smartphones, wearable devices, tablets, digital appliances, network systems, and memory, system LSI, foundry and LED solutions. For the latest news, please visit the Samsung Newsroom at news.samsung.com.

"Samsung provides limited warranty for its LED products, the full text of which is available at <https://www.samsung.com/led/support/warranties>"

Copyright © 2021 Samsung Electronics Co., Ltd. All rights reserved.

Samsung is a registered trademark of Samsung Electronics Co., Ltd.

Specifications and designs are subject to change without notice. Non-metric weights and measurements are approximate. All data were deemed correct at time of creation. Samsung is not liable for errors or omissions. All brand, product, service names and logos are trademarks and/or registered trademarks of their respective owners and are hereby recognized and acknowledged.

Samsung Electronics Co., Ltd.

95, Samsung 2-ro

Giheung-gu

Yongin-si, Gyeonggi-do, 446-711

KOREA

www.samsungled.com

SAMSUNG